

# HITACHI

Liquid Crystal Projector

## CP-S225/CP-X275

(CP-S225WA/CP-X275WA)

### USER'S MANUAL Vol.1 Basic

Please read this user's manual thoroughly to ensure correct usage through understanding.

### BEDIENUNGSANLEITUNG Teil 1 Grundlagen

Bitte lesen Sie diese Benutzerhandbuch zugunsten der korrekten Bedienung aufmerksam.

### MANUEL D'UTILISATION Vol.1 Fondements

Nous vous recommandons de lire attentivement ce manuel pour bien assimiler le fonctionnement de l'appareil.

### MANUALE D'ISTRUZIONI Vol.1 Informazioni di base

Vi preghiamo voler leggere attentamente il manuale d'istruzioni in modo tale da poter comprendere quanto riportato ai fini di un corretto utilizzo del proiettore.

### MANUAL DE USUARIO Vol.1 Básico

Lea cuidadosamente este manual del usuario para poder utilizar correctamente el producto.

### GEBRUIKSAANWIJZING Vol.1 Basis

Lees voor het gebruik alstublieft deze handleiding aandachtig door, om volledig profijt te hebben van de uitgebreide mogelijkheden.

### BRUKERHÅNDBOK Vol.1 Grunnleggende

Vennligst les denne bruksanvisningen grundig for å være garantert driftssikker bruk.

### NSTRUÇÕES DO PROPRIETÁRIO Vol.1 Básico

Para assegurar o uso correto do equipamento, por favor leia atentamente este manual do utilizador.

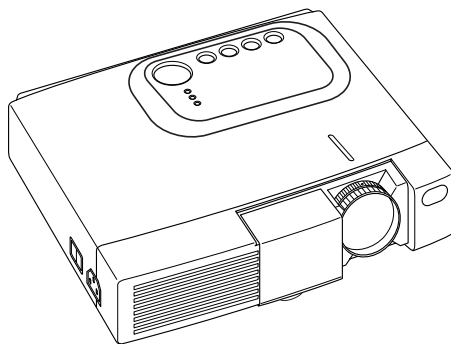

ENGLISH

DEUTSCH

FRANÇAIS

ITALIANO

ESPAÑOL

NERLANDS

NORSK

PORTGÊS

# USER'S MANUAL Vol.1 (Basic)

Thank you for purchasing this projector.



**WARNING** • Please read the accompanying manual “SAFETY INSTRUCTIONS” and this “USER'S MANUAL” thoroughly to ensure correct usage through understanding. After reading, store this instruction manual in a safe place for future reference.

ENGLISH

**NOTE**

- The information in this manual is subject to change without notice.
- The manufacturer assumes no responsibility for any errors that may appear in this manual
- The reproduction, transmission or use of this document or contents is not permitted without express written authority.

**TRADEMARK ACKNOWLEDGEMENT :**

- PS/2, VGA and XGA are registered trademarks of the International Business Machines Corporation.
- Apple, Mac and ADB are registered trademarks of Apple Computer, Inc.
- VESA and SVGA are trademarks of the Video Electronics Standard Association.
- Windows is a registered trademark of Microsoft Corporation.
- All other trademarks are the property of their respective owners.

## CONTENTS

	Page		Page
<b>PROJECTOR FEATURES .....</b>	<b>2</b>	<b>CORRECTING KEYSTONE</b>	
<b>PREPARATIONS .....</b>	<b>2</b>	<b>DISTORTIONS .....</b>	<b>20</b>
<b>PART NAMES .....</b>	<b>4</b>	<b>USING THE MAGNIFY</b>	
<b>SETTING UP</b>		<b>FEATURE.....</b>	<b>21</b>
<b>THE PROJECTOR .....</b>	<b>6</b>	<b>FREEZING THE SCREEN .....</b>	<b>21</b>
<b>CONNECTING</b>		<b>SIGNAL SEARCHING.....</b>	<b>22</b>
<b>YOUR DEVICES.....</b>	<b>8</b>	<b>SELECTING THE ASPECT</b>	
<b>USING THE REMOTE</b>		<b>RATIO.....</b>	<b>22</b>
<b>CONTROL .....</b>	<b>12</b>	<b>TEMPORARILY BLANKING</b>	
<b>TURNING ON THE POWER .....</b>	<b>14</b>	<b>THE SCREEN.....</b>	<b>22</b>
<b>TURNING OFF THE POWER .....</b>	<b>16</b>	<b>USING THE MENU</b>	
<b>ADJUSTING THE VOLUME .....</b>	<b>17</b>	<b>FUNCTIONS.....</b>	<b>23</b>
<b>TEMPORARILY MUTING</b>		<b>THE LAMP .....</b>	<b>24</b>
<b>THE SOUND.....</b>	<b>17</b>	<b>THE AIR FILTER.....</b>	<b>26</b>
<b>ADJUSTING THE POSITION.....</b>	<b>18</b>	<b>OTHER CARE .....</b>	<b>28</b>
<b>USING THE AUTOMATIC</b>		<b>REGULATORY NOTICES.....</b>	<b>29</b>
<b>ADJUSTMENT FEATURE .....</b>	<b>19</b>		

## PROJECTOR FEATURES

This liquid crystal projector is used to project various computer signals as well as NTSC / PAL / SECAM video signals onto a screen. Little space is required for installation and large images can easily be realized.

### ● **Ultra High Brightness**

Crisp, ultra-bright presentations is achieved by using a UHB (ultra high brightness) lamp and a highly efficient optical system

### ● **Partial Magnification Function**

Interesting parts of images can be magnified for closer viewing

### ● **Keystone Distortion Correction**

Quick correction of distorted images electrically

### ● **Whisper Mode Equipped**

Special mode is available for reducing projector noise to achieve quieter operation

## PREPARATIONS

Your projector should come with the items shown below. Check to make sure that all the items are included. Contact your dealer if anything is missing.

**NOTE** • Keep the original packing material for future reshipment.

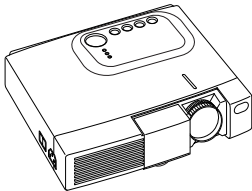

**Projector**



**Power cord  
(US Type)**



**Power cord  
(UK Type)**



**Power cord  
(Europe Type)**



**User's Manuals  
(Vol.1/Vol.2)  
Safety Instructions**

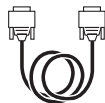

**RGB cable**

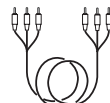

**Video/Audio cable**



**Two AA batteries  
(for the remote control)**



**Soft carrying case**



**Remote control**

**WARNING** Precautions to observe in regards to the power cord: Please use extra caution when connecting the projector's power cord as incorrect or faulty connections may result in FIRE AND/OR ELECTRICAL SHOCK. Please adhere to the following safety guidelines to insure safe operation of the projector:

- Only plug the power cord into outlets rated for use with the power cord's specified voltage range.
- Only use the power cord that came with the projector.
- NEVER ATTEMPT TO DEFEAT THE GROUND CONNECTION OF THE THREE-PRONGED PLUG!
- Make sure that you firmly connect the power cord to the projector and wall outlet.

### 1 Connect your devices to the projector



Connect your computer, VCR and/or other devices you will be using to the projector.

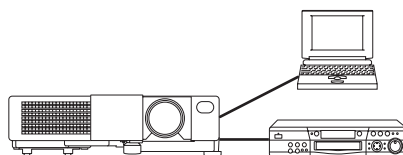

### 2 Insert the batteries into the remote control

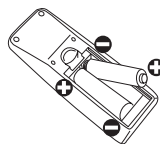

### 3 Connect the power cord

- (1) Connect the connector of the electrical power cord to the AC inlet of the main unit.
- (2) Firmly plug the power cord's plug into the outlet

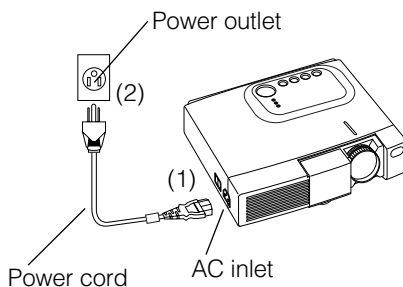

# PART NAMES

# THE PROJECTOR

 Indicates the corresponding reference page

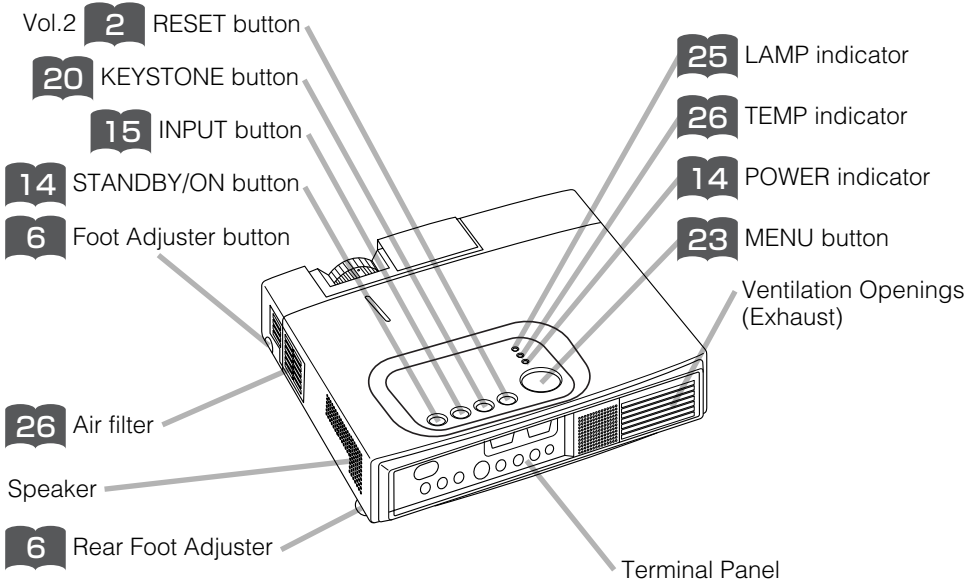
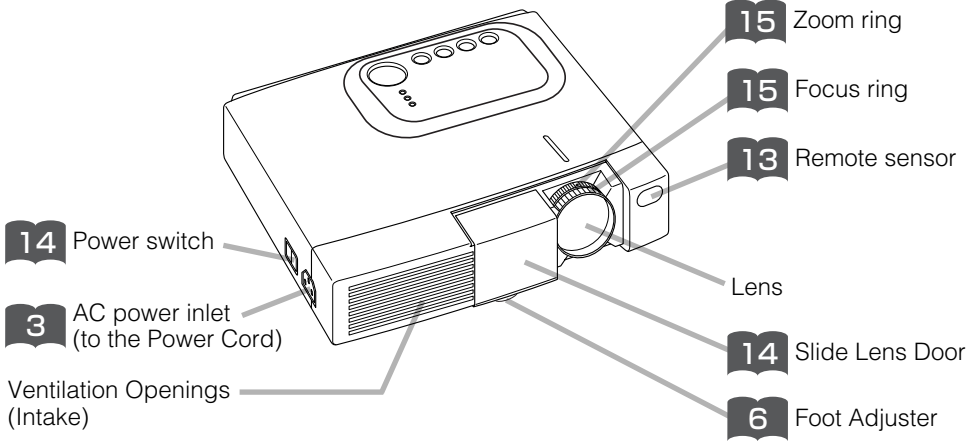

# THE TERMINAL PANEL

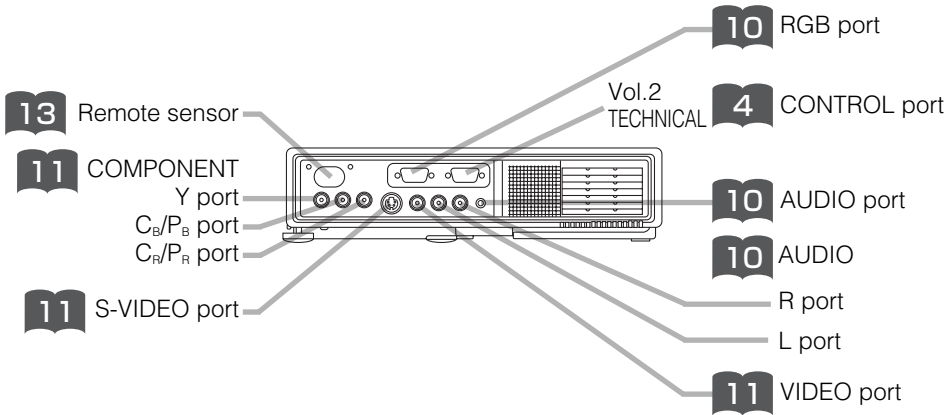

# THE REMOTE CONTROL

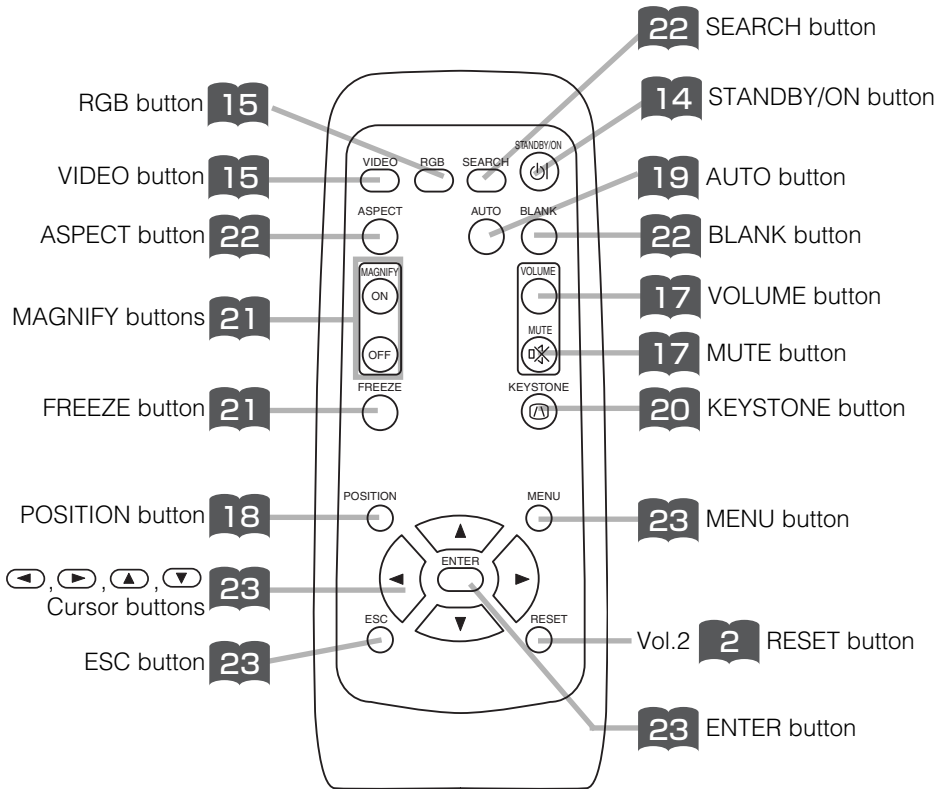

# SETTING UP THE PROJECTOR

- CAUTION** • Install the projector in a suitable environment according to instructions of the accompanying manual “SAFETY INSTRUCTIONS” and this manual.
- If you press the elevator buttons without holding the projector, the projector might crash down, overturn, smash your fingers and possibly result in malfunction. To prevent damaging the projector and injuring yourself, ALWAYS HOLD THE PROJECTOR whenever using the elevator buttons to adjust the elevator feet.

## Angle Adjustment

Use the foot adjusters on the bottom of the projector to adjust the projection angle. It is variable within  $0^{\circ}$  to  $10^{\circ}$  approximately.

- 1 Lift up the front side of the projector, and pressing the foot adjuster button, adjust the projection angle**

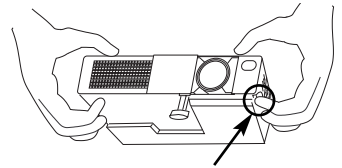

Press the foot adjuster button

- 2 Release the button to lock at the desired angle**

- 3 Make the rear foot adjuster screw to adjust the left-right slope**

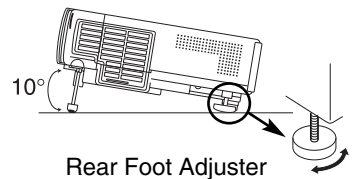

Rear Foot Adjuster

# Adjusting the Screen Size and Projection Distance

Refer to the illustrations and tables below to determine the screen size and projection distance.

The values shown in the table are calculated for a full size screen (CP-S225: 800x600 pixels/CP-X275: 1024x768 pixels).

a: Distance from the projector to the screen ( $\pm 10\%$ )

b: Distance from the lens center to the bottom of the screen ( $\pm 10\%$ )

The screen

**Top view**

If 4:3 aspect ratio

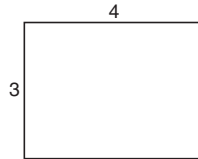
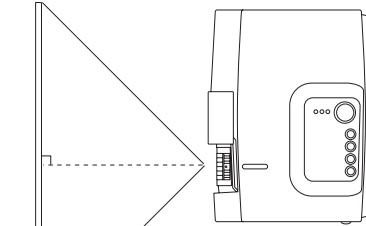

Screen size [inch (m)]	a [inch (m)]		b [inch (cm)]
	Min.	Max.	
40 (1.0)	37 (0.9)	46 (1.2)	3 (8.7)
60 (1.5)	57 (1.5)	69 (1.8)	5 (13.1)
80 (2.0)	77 (1.9)	93 (2.4)	7 (17.4)
100 (2.5)	96 (2.4)	116 (2.9)	9 (21.8)
120 (3.0)	116 (2.9)	139 (3.5)	10 (26.1)
150 (3.8)	145 (3.7)	174 (4.4)	13 (32.7)
200 (5.0)	194 (4.9)	233 (5.9)	17 (43.5)

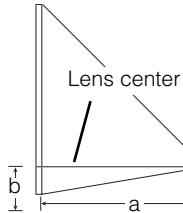

**Side view**

The screen

**Top view**

If 16:9 aspect ratio

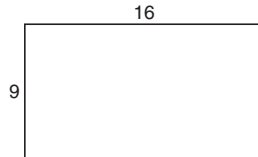
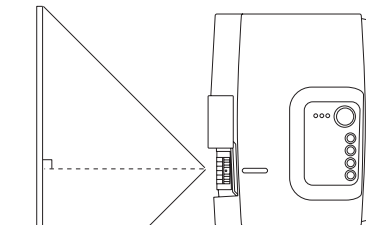

Screen size [inch (cm)]	a [inch (m)]		b [inch (cm)]
	Min.	Max.	
30 (0.8)	30 (0.8)	38 (1.0)	0 (1)
40 (1.0)	41 (1.0)	50 (1.3)	0 (1)
60 (1.5)	62 (1.6)	76 (1.9)	1 (2)
80 (2.0)	83 (2.1)	101 (2.6)	1 (2)
100 (2.5)	105 (2.7)	127 (3.2)	1 (3)
120 (3.0)	126 (3.2)	152 (3.9)	1 (4)
150 (3.8)	158 (4.0)	190 (4.8)	2 (4)
200 (5.0)	212 (5.4)	254 (6.4)	2 (6)

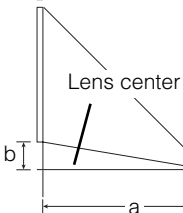

**Side view**



## CONNECTING YOUR DEVICES

### **Devices You Can Connect to the Projector** **(Refer to this section for planning your device configuration to use for your presentation.)**



**CAUTION** • Incorrect connecting could result in fire or electrical shock. Please read this manual and the separate “SAFETY INSTRUCTIONS”.

### **ATTENTION** Precautions to observe when connecting other devices to the projector

- Whenever attempting to connect other devices to the projector, please thoroughly read the manual of each device to be connected.
- **TURN OFF ALL DEVICES** prior to connecting them to the projector. Attempting to connect a live device to the projector may generate extremely loud noises or other abnormalities that may result in malfunction and/or damage to the device and/or projector. Refer to the “TECHNICAL” of the USER’S MANUAL (Vol.2) for the pin assignment of connectors and RS-232C communication data.
- Make sure that you connect devices to the correct port. Incorrect connection may result in malfunction and/or damage to the device and/or projector.
- A component cable and some other cables have to be used with core set. Use the accessory cable or a designated-type cable for the connection. For cables that have a core only at one end, connect the core to the projector.
- Secure the screws on the connectors and tighten.



Indicates the corresponding reference page

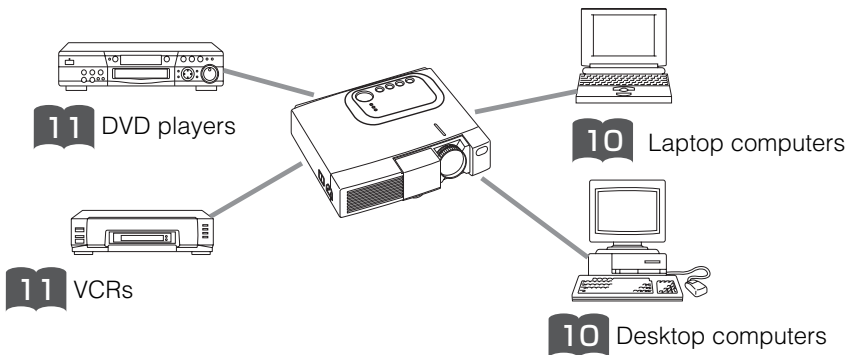

## Ports and Cables

Refer to the table below to find out which projector port and cable to use for connecting a given device. Use this table for determining which cables to prepare.

Function	Projector Port	Connection Cables
RGB input	RGB IN	Accessory RGB cable or optional RGB cable with D-sub 15-pin shrink jack and inch thread screws
AUDIO input (from the computer)	AUDIO IN	Optional audio cable with stereo mini jack
RS-232C communication	CONTROL	Optional RS-232C cable
S-video input	S-VIDEO IN	Optional S-video cable with mini DIN 4-pin jack
Video input	VIDEO IN	Accessory audio/video cable
Component video input	COMPONENT VIDEO Y	Optional component video cable
	COMPONENT VIDEO C <sub>B</sub> /P <sub>B</sub>	
	COMPONENT VIDEO C <sub>R</sub> /P <sub>R</sub>	
Audio input (from video equipment)	AUDIO IN L	Accessory audio/video cable or optional audio cable with RCA jack
	AUDIO IN R	

### **NOTE** About Plug-and-Play Capability

- This projector is compatible with VESA DDC 1/2B. Plug-and-Play can be achieved by connecting this projector to computers that are VESA DDC (display data channel) compatible. Please take advantage of this function by connecting the accessory RGB cable to the RGB IN port (DDC 1/2B compatible). Plug-and-Play may not work properly if any other type of connection is attempted.
- Plug-and-Play is a system composed of the computer, its operating system and peripheral equipment (i.e. display devices).
- Please use the standard drivers as this projector is a Plug-and-Play monitor.

## CONNECTING YOUR DEVICES (continued)

### Connecting to a Computer

**ATTENTION** Whenever attempting to connect a laptop computer to the projector, be sure to activate the laptop's RGB external image output (set the laptop to CRT display or to simultaneous LCD and CRT display). For details on how this is done, please refer to the instruction manual of the corresponding laptop computer.

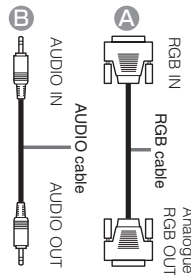
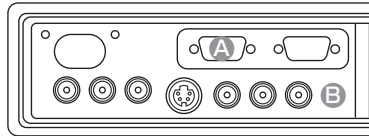

**Laptop computer**



**Desktop computer**

#### NOTE

- Some computers may have multiple display screen modes. Use of some of these modes will not be possible with this projector.
- For some RGB input modes, the optional Mac adapter is necessary.

## Connecting to a DVD Player

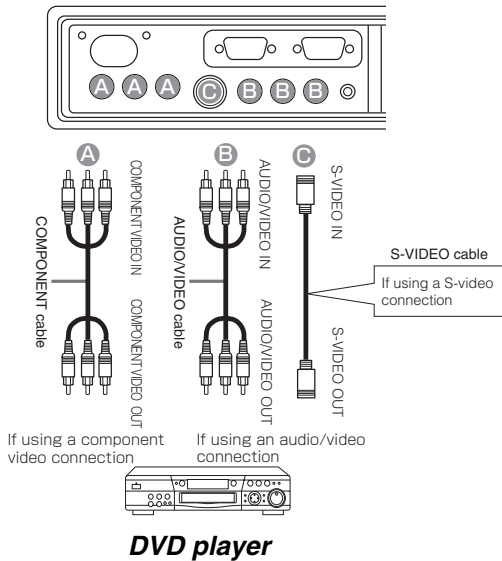

## Connecting to a VCR

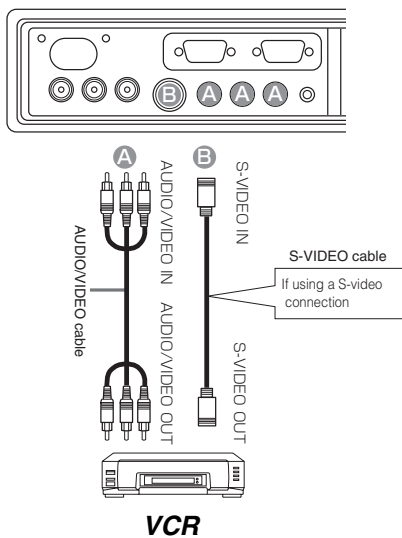

# USING THE REMOTE CONTROL

## **Putting batteries into the remote control unit**



### **CAUTION** Precautions to observe in regards to the batteries

Always handle the batteries with care and use them only as directed. Improper use may result in battery cracking or leakage, which could result in fire, injury and/or pollution of the surrounding environment.

- Keep the battery away from children and pets.
- Be sure to use only the batteries specified for use with the remote control. Do not mix new batteries with used ones.
- When inserting batteries, verify that the plus and minus terminals are aligned correctly (as indicated in the remote control).
- When you dispose the battery, you should obey the law in the relative area or country.

### **1 Remove the battery cover**

Slide back and remove the battery cover in the direction of the arrow.

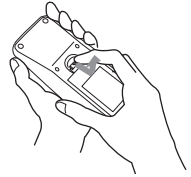

### **2 Insert the batteries**

Align and insert the two AA batteries (that came with the projector) according to their plus and minus terminals (as indicated in the remote control).

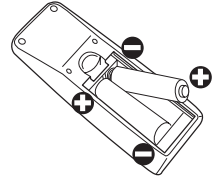

### **3 Close the battery cover**

Replace the battery cover in the direction of the arrow and snap it back into place.

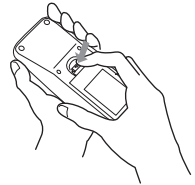

## Operating the remote control

- The remote control works with both the projector's front and rear remote sensors.
- The range of the remote sensor on the front is 3 meters with a 90-degree range (45 degrees to the left and right of the remote sensor), and back is 3 meters with a 60-degree range.
- Since the remote control uses infrared light to send signals to the projector (Class 1 LED), be sure to use the remote control in an area free from obstacles that could block the remote control's output signal to the projector.

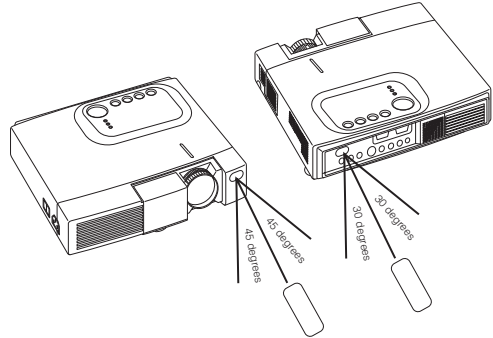

### **ATTENTION** Precautions to observe when using the remote control

- Do not drop or otherwise expose the remote control to physical impact.
- Do not get the remote control wet or place it on wet objects. Doing so may result in malfunction.
- Remove the batteries from the remote control and store them in a safe place if you won't be using the remote control for an extended period.
- Replace the batteries whenever the remote control starts to malfunction.
- When strong light, such as direct sunlight or light from an extremely close range (such as from an inverter fluorescent lamp), hits the projector's remote sensor, the remote control may cease to function. Adjust the direction of the projector to keep light from directly hitting the projector's remote sensor.

# TURNING ON THE POWER

## Precautions

Connect all devices to be used to the projector prior to turning on the power.



**WARNING** When the power is ON, a strong light is emitted. Do not look into the lens.

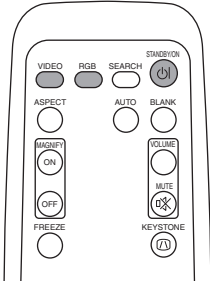

**Control panel**

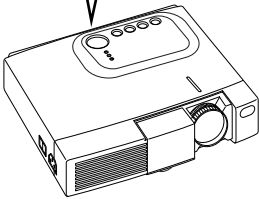
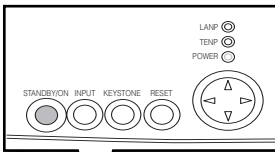

**NOTE** Turn the power on/off in right order.

- Power on the projector before the computer or video tape recorder.
- Power off the projector after the computer or video tape recorder.

**1**

**Make sure that the power cord is firmly and correctly connected to the projector and outlet**



**2**

**Turn on the projector's power**

Set the power switch to [ I ] (ON). The projector will go to STANDBY mode and the POWER indicator will light to solid orange.

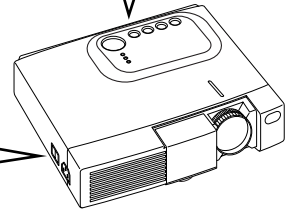
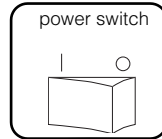
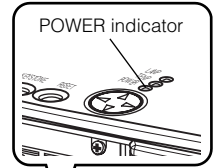

**3**

**Press the STANDBY/ON button (control panel or remote control)**

- The projector begins warming up and the POWER indicator blinks green.
- The POWER indicator stops blinking and lights to solid green once the projector's power is completely on.



**4**

**Open the slide lens door**

The picture is projected.

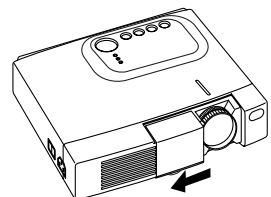

## Selecting an Input Signal

5

### Using the remote control

#### If selecting RGB input Press the RGB button

Press this button to switch to the devices connected to RGB IN as illustrated below.



#### If selecting video input Press the VIDEO button

Press this button to toggle between the devices connected to VIDEO IN, S-VIDEO IN and COMPONENT VIDEO. As illustrated below, each time you press the VIDEO button, the projector switches between VIDEO IN, S-VIDEO IN and COMPONENT VIDEO. Select the signal you wish to project.



### Using the projector's control panel

#### Press the INPUT button

As illustrated below, each time you press the INPUT button, the projector switches between its input signal ports. Select the signal you wish to project.

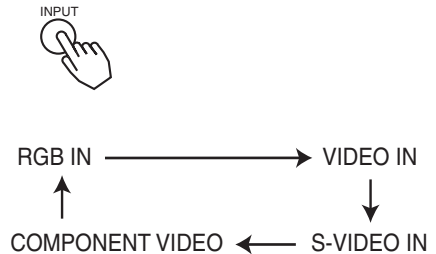

6

### Use the zoom ring to adjust the screen size

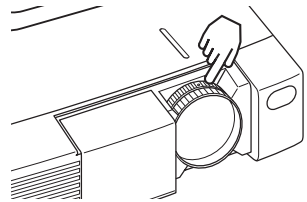

7

### Use the focus ring to focus the picture

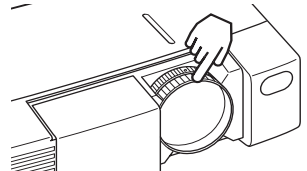



# TURNING OFF THE POWER

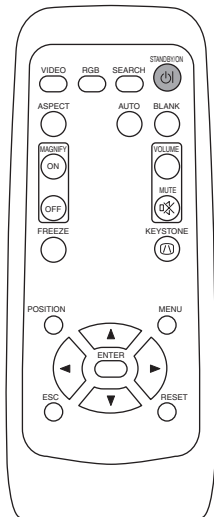

## 1 Press the **STANDBY/ON** button (control panel or remote control)

The message "Power off?" will appear on the screen for approximately 5 seconds.



## 2 Press the **STANDBY/ON** button again (control panel or remote control)

Press the STANDBY/ON button again while the "Power off?" message is visible. The projector lamp goes off and starts cooling down. The POWER indicator blinks orange while the lamp cools down. (Pressing the STANDBY/ON button while the POWER indicator is blinking orange has no effect.)

The system goes into the STANDBY mode after cooling down and the POWER indicator stops blinking orange and then lights to solid orange.



### Control panel

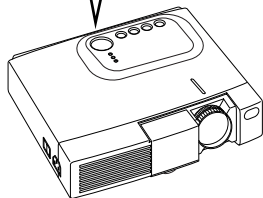
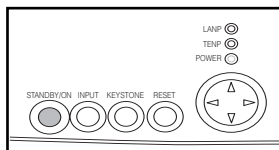

## 3 Check that the **POWER** indicator stops blinking and lights to solid orange. Switch the power switch to [O] (OFF).

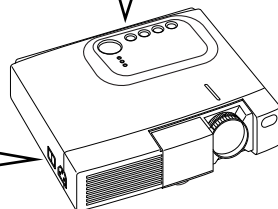
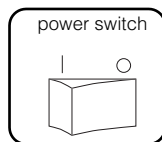
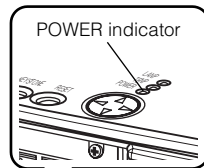

### NOTE

- Except in emergencies, follow the above-mentioned procedure for turning power off.

## 4 Confirm that the **POWER** indicator has gone off and then close the slide lens door.

When the projector has completed powering down, the POWER indicator will go off.

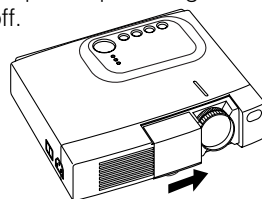

# ADJUSTING THE VOLUME

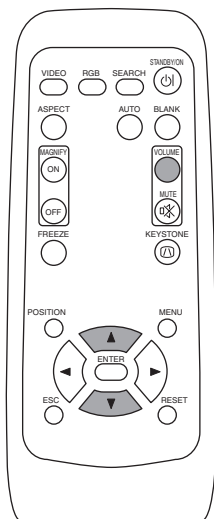

## 1 Press the **VOLUME** button

As illustrated on the right, a dialog will appear on the screen to aid you in adjusting the volume.

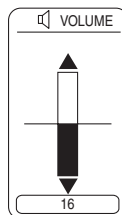

ENGLISH

## 2 Press the **▲**, **▼** buttons to adjust the volume

Press the VOLUME button again to close the dialog and complete this operation. (Even if you don't do anything, the dialog will automatically disappear after a few seconds.)



▲ Press this to increase the volume

▼ Press this to decrease the volume

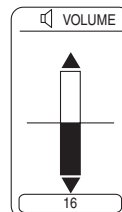

# TEMPORARILY MUTING THE SOUND

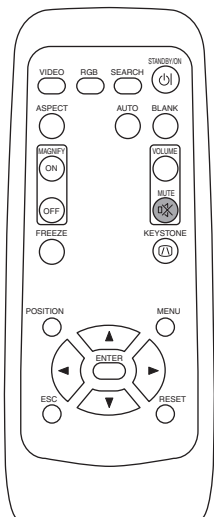

## 1 Press the **MUTE** button

As illustrated on the right, a dialog will appear on the screen indicating that you have muted the sound. Press the VOLUME button to close the dialog. (Even if you don't do anything, the dialog will automatically disappear after a few seconds.)

Press the MUTE button again to restore the sound.

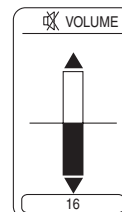

# ADJUSTING THE POSITION

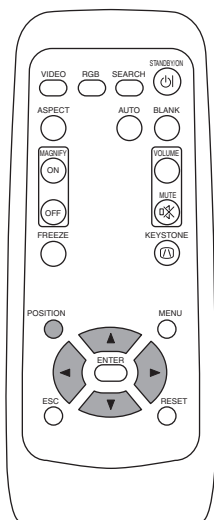

## 1 Press the **POSITION** button

As illustrated on the right, a dialog will appear on the screen to aid you in adjusting the position.



## 2 Use the **←, →, ▲, ▼** buttons to adjust the position

When you want to initialize the position, press the RESET button during adjustment.

Press the POSITION button again to close the dialog and complete this operation. (Even if you don't do anything, the dialog will automatically disappear after a few seconds.)

This function is only available for RGB IN input.

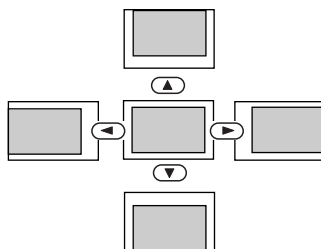
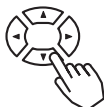

# USING THE AUTOMATIC ADJUSTMENT FEATURE

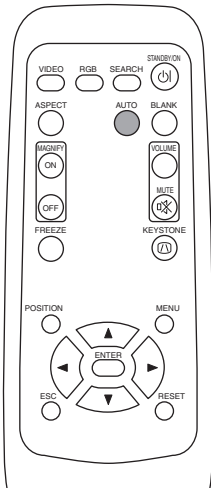

1

## Press the **AUTO** button



### **Automatic Adjustment for RGB Input**

Horizontal position (H. POSIT), vertical position (V. POSIT), clock phase (H. PHASE) and horizontal size (H. SIZE) are automatically adjusted.

Make sure that the application window is set to its maximum size prior to attempting to use this feature. Dark pictures may still be incorrectly adjusted. Use a bright screen when adjusting.

### **Automatic Adjustment for Video Input**

The signal type best suited for the respective input signal is selected automatically.

This feature is available only if VIDEO is set to AUTO in the INPUT menu.

### **NOTE**

The automatic adjustment operation requires approximately 10 seconds. Also, please note that it may not function correctly with some input signals.

# CORRECTING KEYSTONE DISTORTIONS

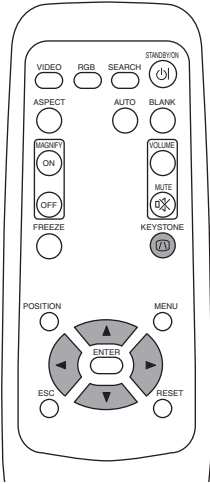

## 1 Press the **KEYSTONE** button

As illustrated on the right, a dialog will appear on the screen to aid you in correcting the distortion.

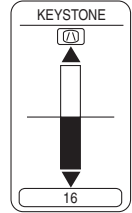

## 2 Use the **▲, ▼** buttons to correct the distortion

Press the **KEYSTONE** button again to close the dialog and complete this operation. (Even if you don't do anything, the dialog will automatically disappear after a few seconds.)



### NOTE

- This function may not work well with some types of input signals.
- The adjustable range for correcting keystone distortions will vary with the type of input signal.

# USING THE MAGNIFY FEATURE

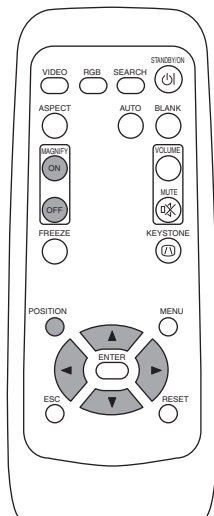

## 1 Press the **MAGNIFY (ON)** button

The projector enters MAGNIFY mode.



## 2 Press the **POSITION** button, then use the , , , buttons to select the area to enlarge and then press the **POSITION** button again to confirm your selection

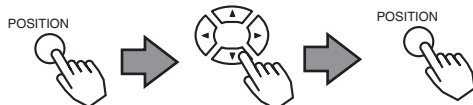

## 3 Press the , buttons to zoom in and out of the selected area.

Press the MAGNIFY (OFF) button to exit MAGNIFY mode and restore the screen to normal. (The projector will also automatically exit MAGNIFY mode if there is a change in the input signal's state.)



### NOTE

The projector will automatically exit from MAGNIFY mode if either the INPUT SELECT, AUTO, ASPECT or VIDEO feature is used, or, if there is a change in the input signal's state.

# FREEZING THE SCREEN

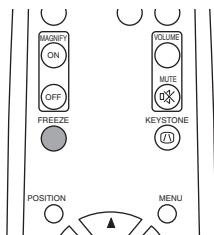

## 1 Press the **FREEZE** button

The [||] icon appears and the screen will freeze at the current image. Press the FREEZE button again and the [▶] appears as the projector exits FREEZE mode.



### NOTE

- The projector will automatically exit from FREEZE mode if either the POSITION, VOLUME, MUTE, AUTO, BLANK ON/OFF or MENU ON/OFF feature is used, or, if there is a change in the input signal's state.
- If the projector continues projecting the same image for a long time (i.e. you forget to exit FREEZE mode), the image might possibly remain as an afterimage. Do not leave the projector in FREEZE mode for too long.

## SIGNAL SEARCHING

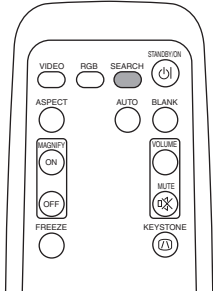

### 1 Press the **SEARCH** button

When you press the SEARCH button, the projector begins searching for input signals. If it detects an input signal, the search will cease and the projector will project the detected signal. If the projector is unable to find an input signal at any of its ports, it will return to the state it was in prior to the search.



## SELECTING THE ASPECT RATIO

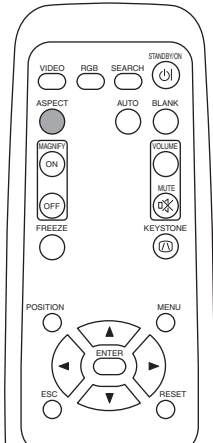

### 1 Press the **ASPECT** button



#### RGB IN, COMPONENT VIDEO

(HDTV signals : 1125i (1035i/1080i), 750p)

4:3 ↔ 16:9

#### VIDEO IN, S-VIDEO IN, COMPONENT VIDEO

(Non-HDTV signals : 525i, 525p, 625i)

4:3 → 16:9 → SMALL  
↑

## TEMPORARILY BLANKING THE SCREEN

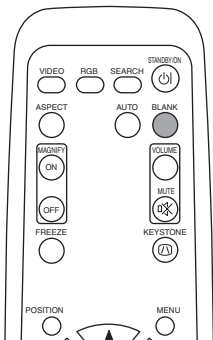

### 1 Press the **BLANK** button

The input signal screen is shut off, and a blank screen appears. You can set the blank screen using the menu (from the SCREEN menu, select BLANK). Press the BLANK button again to remove the blank screen, and return to the input signal screen.



# USING THE MENU FUNCTIONS

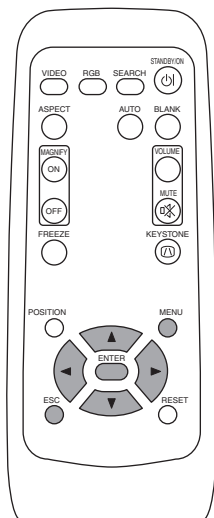

## 1 Press the MENU button

The menu display appears on the screen. The projector has the following menus: MAIN, PICTURE-1, PICTURE-2, INPUT, SCREEN, and OPTION. Select a menu using the / buttons. The current settings of the items that can be manipulated via the selected menu appear.



## 2 Select a menu using the / buttons, then press the or ENTER button.

The display of the selected menu appears.

[ex. Adjusting SHARPNESS]

Use the / buttons to select PICTURE-1, then press the or ENTER button.

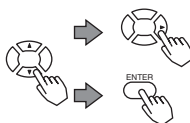

MENU	
MAIN	COLOR BAL R -1
PICTURE-1	COLOR BAL B +1
PICTURE-2	SHARPNESS -1
INPUT	COLOR +1
SCREEN	TINT -1
OPTION	

SELECT

## 3 Select an item using the / buttons, then press the or ENTER button.

The operation display of the selected item appears. To adjust a numerical value, press the or ENTER button again to switch to the single menu (small display showing only the operation display area).

[ex. Adjusting SHARPNESS]

Use the / buttons to select SHARPNESS, then press the or ENTER button.

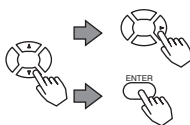

MENU	
MAIN	COLOR BAL R
PICTURE-1	COLOR BAL B
PICTURE-2	SHARPNESS
INPUT	COLOR
SCREEN	TINT
OPTION	

SELECT

## 4 Press the / buttons to adjust the level.

Press the MENU button to hide the menu and finish your operation. Alternatively, press the or ESC button to return to the previous display.

[ex. Adjusting SHARPNESS]

Use the / buttons to adjust the SHARPNESS.





## THE LAMP



**HIGH VOLTAGE**  
**HIGH TEMPERATURE**  
**HIGH PRESSURE**

Before replacing the lamp, check the serial number of the replacement lamp bulb (sold separately: DT00401 for CP-S225/DT00461 for CP-X275), then contact your local dealer. Before replacing the lamp, turn off the power, and unplug the power cord, then wait at least 45 minutes, in order to ensure that the lamp is properly cooled. Removing the lamp bulb while it is still hot could cause burns, or cause the lamp bulb to burst.

**⚠ WARNING** The LCD projector uses a glass lamp bulb. It is a mercury lamp with high internal pressure. High-pressure mercury lamps can break with a loud bang, or burn out, if jolted or scratched, or through wear over time. Each lamp has a different lifetime, and some may burst or burn out soon after you start using them. In addition, when the bulb bursts, it is possible for shards of glass to fly into the lamp housing, and for gas containing mercury to escape from the projector's vent holes.

- Handle with care: jolting or scratching could cause the lamp bulb to burst during use.
- If the replace lamp indicator (see "Related Messages" (Vol.2 **7**) and "Regarding the indicator Lamps" (Vol.2 **8**)) comes on, replace the lamp as soon as possible. Using the lamp for long periods of time, or past the replacement date, could cause it to burst. Do not use old (used) lamps; this is a cause of breakage.
- If the lamp breaks soon after the first time it is used, it is possible that there are electrical problems elsewhere besides the lamp. If this happens, contact your local dealer.
- If the lamp should break (it will make a loud bang when it does), ventilate the room well, and make sure not to breathe the gas that comes out of the projector vents, or get it in your eyes or mouth.
- If the lamp should break (it will make a loud bang when it does), unplug the power cord from the outlet, and make sure to request a replacement lamp from your local dealer. Note that shards of glass could damage the projector's internals, or cause injury during handling, so please do not try to clean the projector or replace the lamp yourself.
- Obey local ordinances when disposing of used lamps. In most cases, it is possible to dispose of used bulbs in the same manner as used glass bottles, but in some cases, bulbs are sorted separately.
- Do not use the projector with the lamp cover removed.

## Replacing the lamp

All projector lamps will wear out eventually. If used for long periods of time, the image could become darkened, and the color contrast could be impacted as well. We recommend that you replace your lamps early. If the LAMP indicator turns red, or a message prompts you to replace the lamp when you power up the projector, the lamp needs to be replaced. (See "Related Messages" (Vol.2 [7](#)) and "Regarding the Indicator Lamps" (Vol.2 [8](#)) for details.)

- 1** Turn off the projector, and unplug the power cord. Allow the lamp bulb to cool for at least 45 minutes, and prepare a new lamp (sold separately: DT00401 for CP-S225/DT00461 for CP-X275)

- 2** After making sure that the projector has cooled adequately, slowly flip over the projector, so that the bottom is facing up

- 3** Unscrew the 2 screws, and remove the lamp cover

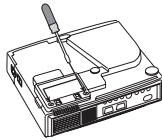

- 4** Unscrew the 1 screw, and slowly pull out the lamp by the handle  
 • Be careful not to touch the inside of the lamp case.

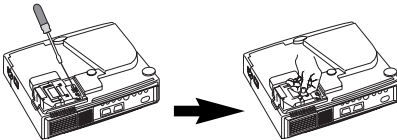

- 5** Insert the new lamp, and tighten the 1 screw firmly to lock it in place

- Also steadily push the opposite side of the screwed side of the lamp into the unit.

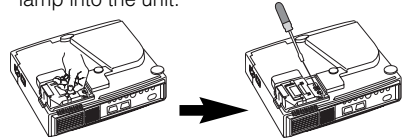

- 6** Replace the lamp cover, and tighten the 2 screws firmly to lock it in place

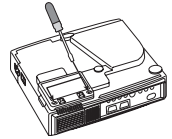

- 7** Slowly turn the projector so that the top is facing up

- 8** Turn on the projector power, and using the menu, reset the lamp timer

- To reset the lamp timer, from the OPTION menu, select LAMP TIME. (See "OPTION menu" (Vol.2 [6](#)) for details.)

**ATTENTION** • Make sure that the screws are screwed in firmly. Loose screws could result in damage or injury.



- Do not use with lamp cover removed.
- Do not reset the lamp timer without replacing the lamp. Reset the lamp timer always when replacing the lamp. The message functions will not operate properly if the lamp timer is not reset correctly.
- When the lamp has been replaced after the message of "CHANGE THE LAMP ...THE POWER WILL TURN OFF AFTER 0 hr." is displayed, or the LAMP indicator is red, complete the following operation within 10 minutes of switching power ON.

**NOTE** • The LAMP indicator is also red when the lamp unit reaches high temperature.

Before replacing the lamp, switch power OFF, wait approximately 20 minutes, and switch power ON again. If the LAMP indicator is still red, replace the lamp.

# THE AIR FILTER

## ***Caring for the air filter***

The air filter should be cleaned about every 100 hours. If the LAMP indicator and TEMP indicator blink red simultaneously, or a message prompts you to clean the air filter when you turn on the unit, the filter needs to be cleaned. (See "Related Messages" (Vol.2 ) and "Regarding the Indicator Lamps" (Vol.2 ) for details.)

### **1 Turn off the projector, and unplug the power cord**

### **2 Apply a vacuum cleaner to the top of the air filter cover to clean the air filter**

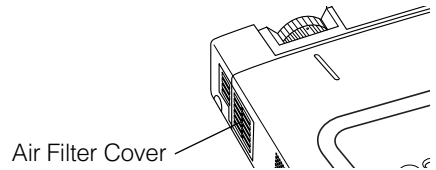

### **3 Turn on the projector, and use the menu to reset the filter timer**

- To reset the air filter timer, from the OPTION menu, select FILTER TIME. (See "OPTION menu" (Vol.2 ) for details.)

## **Replacing the air filter**

If the soiling will not come off the air filter, or it becomes damaged, then it needs to be replaced. Please contact your local dealer, after confirming the model of your separately sold replacement air filter. (See "Optional Parts" on Vol.2 [10](#).)

### **1 Turn off the projector, and unplug the power cord. Prepare a new air filter (one specified for your projector)**

### **2 Remove the air filter cover and air filter**

### **3 Insert the new filter, and replace the filter cover**

### **4 Turn on the projector power, and using the menu, reset the filter timer**

- To reset the filter timer, from the OPTION menu, select FILTER TIME. (See "OPTION menu" (Vol.2 [6](#)) for details.)

**ATTENTION** • Make sure to turn off the power and unplug the power cord before caring for the unit. Please carefully read "Safety Instructions", in order to care for your projector correctly.

- Do not use with air filter cover removed.
- If the air filter becomes clogged by dust or the like, internal temperature rises and could cause malfunction. The power is automatically turned off in order to prevent the unit from overheating internally.

## OTHER CARE

### **Caring for the inside of the projector :**

In order to ensure the safe use of your projector, please have it cleaned and inspected by your local dealer about once every 2 years. Never try to care for the inside of the unit yourself. Doing so is dangerous.

### **Caring for the lens :**

Lightly wipe the lens with a commercially available lens-cleaning wipe. Do not touch the lens directly with your hand.

### **Caring for the cabinet and remote control transmitter :**

Wipe lightly with gauze or a soft cloth. If soiling is severe, dip a soft cloth in water or a neutral cleanser diluted in water, and wipe lightly after wringing well. Then, wipe lightly with a soft, dry cloth.

**ATTENTION** • Make sure to turn off the power and unplug the power cord before caring for the unit. Please carefully read "Safety Instructions" in this manual, in order to care for your projector correctly.

- Do not use cleaners or chemicals other than those listed above, including benzene and paint thinner.
- Do not use aerosols or sprays.
- Do not polish or wipe with hard objects.

# REGULATORY NOTICES

## FCC Statement Warning

ENGLISH

**WARNING:** This equipment has been tested and found to comply with the limits for a Class B digital device, pursuant to Part 15 of the FCC Rules. These limits are designed to provide reasonable protection against harmful interference in a residential installation. This equipment generates, uses, and can radiate radio frequency energy and, if not installed and used in accordance with the instructions, may cause harmful interference to radio communications. However, there is no guarantee that interference will not occur in a particular installation. If this equipment does cause harmful interference to radio or television reception, which can be determined by turning the equipment off and on, the user is encouraged to try to correct the interference by one or more of the following measures:

- Reorient or relocate the receiving antenna.
- Increase the separation between the equipment and receiver.
- Connect the equipment into an outlet on a circuit different from that to which the receiver is connected.
- Consult the dealer or an experienced radio/TV technician for help.

**INSTRUCTIONS TO USERS:** This equipment complies with the requirements of FCC (Federal Communication Commission) equipment provided that the following conditions are met.

The cables may have to be used with the core set to the projector side. Use the cables which are included with the projector or specified.

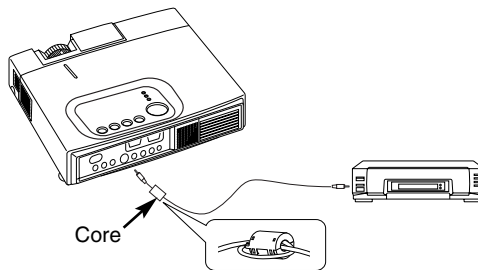

**CAUTION:** Changes or modifications not expressly approved by the party responsible for compliance could void the user's authority to operate the equipment.

## For the Customers in CANADA

**NOTICE:** This Class B digital apparatus complies with Canadian ICES-003.

## Pour les utilisateurs au Canada

**AVIS:** Cet appareil numérique de la Classe B est conforme à la norme NMB-003 du Canada.

# USER'S MANUAL Vol.2 (Extended)

Thank you for purchasing this projector.



**WARNING** • Please read the accompanying manual “SAFETY INSTRUCTIONS” and this “USER'S MANUAL” thoroughly to ensure correct usage through understanding. After reading, store this instruction manual in a safe place for future reference.

**NOTE**

• The information in this manual is subject to change without notice.

- The manufacturer assumes no responsibility for any errors that may appear in this manual
- The reproduction, transmission or use of this document or contents is not permitted without express written authority.

**TRADEMARK ACKNOWLEDGEMENT :**

- PS/2, VGA and XGA are registered trademarks of the International Business Machines Corporation.
- Apple, Mac and ADB are registered trademarks of Apple Computer, Inc.
- VESA and SVGA are trademarks of the Video Electronics Standard Association.
- Windows is a registered trademark of Microsoft Corporation.
- All other trademarks are the property of their respective owners.

## CONTENTS

	Page
<b>MULTIFUNCTIONAL SETTINGS .....</b>	<b>2</b>
<b>WHAT TO DO WHEN YOU THINK A MACHINE DEFECT HAS OCCURRED .....</b>	<b>7</b>
<b>SPECIFICATIONS .....</b>	<b>10</b>
<b>WARRANTY AND AFTER-SERVICE.....</b>	<b>11</b>

For "TECHNICAL" see the end of this manual.

# MULTIFUNCTIONAL SETTINGS

This device has 6 separate menus: **MAIN, PICTURE-1, PICTURE-2, INPUT, SCREEN, OPTION.** Each of these menus is operated using the same methods. The basic operations of these menus are as follows.

**Menu screen display** : Press the "MENU" button.

**Menu selection** : Choose a menu name using the  $\triangle$ / $\nabla$  button, and press the  $\blacktriangleright$  button or the ENTER button.

**Item selection** : Choose an item using the  $\triangle$ / $\nabla$  button, and press the  $\blacktriangleright$  button or the ENTER button.

**Return menu to last previous screen**: Press the  $\blacktriangleleft$  button or the ESC button.

**Execution of settings and/or adjustments**: Operate by using the  $\triangle$ / $\nabla$  button. (For further details, read the explanation for each separate menu.)

**Initialization of settings and/or adjustments**: During operation, press the RESET button. (Note that items whose functions are performed simultaneously with the operation of clock phase, language selection, automatic adjustment, etc., cannot be initialized.)

**End menu operations**: Press the MENU button, or do not perform any operation for several seconds.

## MAIN Menu

With the MAIN menu, the seven items shown in the Table below can be performed.

Perform each operation in accordance with the instructions in the Table.

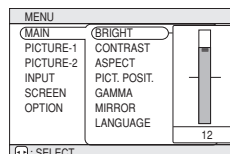

Example : MAIN Menu (BRIGHT)

## MAIN Menu

Item	Description
<b>BRIGHT</b>	<b>Adjust Brightness:</b> Light $\triangle$ $\leftrightarrow$ $\nabla$ Dark
<b>CONTRAST</b>	<b>Adjust Contrast:</b> Strong $\triangle$ $\leftrightarrow$ $\nabla$ Weak
<b>ASPECT</b>	<b>Select Aspect Ratio:</b> At RGB Input or Hi-Vision 1125i(1035i/1080i)/750p of COMPONENT VIDEO Input: 4:3 $\nabla$ $\leftrightarrow$ $\triangle$ 16:9 At VIDEO Input, S-VIDEO Input or 525i/525p/625i of COMPONENT VIDEO Input: 4:3 $\nabla$ $\leftrightarrow$ $\triangle$ 16:9 $\nabla$ $\leftrightarrow$ $\triangle$ SMALL • The SMALL picture may not be displayed correctly with certain input signals.
<b>PICT.POSIT.</b>	<b>Select Picture Position (for 16:9/SMALL Picture):</b> TOP $\nabla$ $\leftrightarrow$ $\triangle$ CENTER $\nabla$ $\leftrightarrow$ $\triangle$ BOTTOM
<b>GAMMA</b>	<b>Select Gamma Mode:</b> NORMAL $\nabla$ $\leftrightarrow$ $\triangle$ CINEMA $\nabla$ $\leftrightarrow$ $\triangle$ DYNAMIC
<b>MIRROR</b>	<b>Select Mirror Status:</b> NORMAL $\nabla$ $\leftrightarrow$ $\triangle$ H:INVERT $\nabla$ $\leftrightarrow$ $\triangle$ V:INVERT $\nabla$ $\leftrightarrow$ $\triangle$ H&V:INVERT
<b>LANGUAGE</b>	<b>Select Menu Language:</b> ENGLISH $\nabla$ $\leftrightarrow$ $\triangle$ FRANÇAIS $\nabla$ $\leftrightarrow$ $\triangle$ DEUTSCH $\nabla$ $\leftrightarrow$ $\triangle$ ESPAÑOL $\nabla$ $\leftrightarrow$ $\triangle$ ITALIANO $\nabla$ $\leftrightarrow$ $\triangle$ NORSK $\nabla$ $\leftrightarrow$ $\triangle$ NEDERLANDS $\nabla$ $\leftrightarrow$ $\triangle$ 日本語 $\triangle$ $\leftrightarrow$ $\nabla$ POTUGUÊS $\nabla$ $\leftrightarrow$ $\triangle$ 中文 $\nabla$ $\leftrightarrow$ $\triangle$ 한글



## PICTURE-1 Menu

With the PICTURE-1 menu, the five items shown in the Table below can be performed. Perform each operation in accordance with the instructions in the Table.

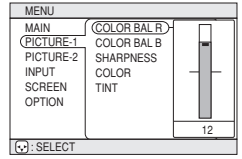

Example : PICTURE-1 Menu (COLOR BAL R)

### PICTURE-1 Menu

Item	Description
<b>COLOR BAL R</b>	<b>Adjust Red Color Balance:</b> Dark ▲ ⇄ ▼ Light
<b>COLOR BAL B</b>	<b>Adjust Blue Color Balance:</b> Dark ▲ ⇄ ▼ Light
<b>SHARPNESS</b>	<b>Adjust Sharpness (for VIDEO/S-VIDEO):</b> Clear ▲ ⇄ ▼ Soft
<b>COLOR</b>	<b>Adjust COLOR (for VIDEO/S-VIDEO/COMPONENT VIDEO):</b> Dark ▲ ⇄ ▼ Light
<b>TINT</b>	<b>Adjust Tint (for VIDEO/S-VIDEO):</b> Green ▲ ⇄ ▼ Red

## PICTURE-2 Menu

With the PICTURE-2 menu, the four items shown in the Table below can be performed. Perform each operation in accordance with the instructions in the Table.

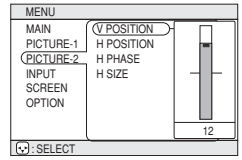

Example : PICTURE-2 Menu (V POSITION)

### PICTURE-2 Menu

Item	Description
<b>V POSITION</b>	<b>Adjust Vertical Position (for RGB):</b> Up ▲ ⇄ ▼ Down
<b>H POSITION</b>	<b>Adjust Horizontal Position (for RGB):</b> Left ▲ ⇄ ▼ Right
<b>H PHASE</b>	<b>Adjust Horizontal Phase (for RGB/COMPONENT VIDEO):</b> Right ▲ ⇄ ▼ Left • Adjust to eliminate flicker.
<b>H SIZE</b>	<b>Adjust Horizontal Size (for RGB):</b> Large ▲ ⇄ ▼ Small • If the horizontal size adjustment is excessive, the image may not be displayed correctly. In such a case, initialize H SIZE with the RESET button.

# MULTIFUNCTIONAL SETTINGS (continued)

## INPUT Menu

With the INPUT menu, the four items shown in the Table below can be performed. With inputting of RGB IN signal, the horizontal and vertical frequencies of the signal will be displayed on the initial screen of the INPUT menu.

Perform each operation in accordance with the instructions in the Table.

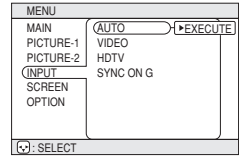

Example : INPUT Menu (AUTO)

## INPUT Menu

Item	Description
<b>AUTO</b>	<p><b>Auto Adjust (for RGB):</b> Automatically adjusts H POSITION, V POSITION, H PHASE, and H SIZE. Use this function with the maximum window size.</p> <p><b>Auto Adjust (for VIDEO/S-VIDEO):</b> Automatically selects the proper VIDEO mode for the current input signal. This function is active only when the AUTO mode is selected for the item VIDEO. Refer to the description for the item VIDEO below.</p> <ul style="list-style-type: none"> <li>• This function may not be available with a PAL60 signal and certain other signals.</li> <li>• The AUTO mode operation requires approximately 10 seconds.</li> <li>• For COMPONENT VIDEO, the signal type is identified automatically even if this function is inactive. For a HDTV signal, refer to the item HDTV below.</li> </ul>
<b>VIDEO</b>	<p><b>Select Mode of Signal Type (for VIDEO/S-VIDEO):</b>            AUTO (▼) ⇔ (▲) NTSC (▼) ⇔ (▲) PAL (▼) ⇔ (▲) SECAM (▼) ⇔ (▲) NTSC4.43 (▼) ⇔ (▲) M-PAL (▼) ⇔ (▲) N-PAL</p> <p>Selecting AUTO mode activates and performs the AUTO function for VIDEO/S-VIDEO. It automatically selects the proper mode from among those above. Use this function if the image becomes unstable with VIDEO/S-VIDEO. (e.g. The image becomes irregular, or lacks color.)</p> <ul style="list-style-type: none"> <li>• AUTO mode may not function correctly with a PAL60 signal and certain other signals.</li> <li>• The AUTO mode operation requires approximately 10 seconds.</li> <li>• For COMPONENT VIDEO, the signal type is identified automatically even if this function is inactive. For a HDTV signal, refer to the item HDTV below.</li> </ul>
<b>HDTV</b>	<p><b>Select HDTV Signal Mode:</b>            1080i (▼) ⇔ (▲) 1035i</p> <ul style="list-style-type: none"> <li>• If the selected HDTV mode is incompatible with the input signal, the picture may be distorted.</li> </ul>
<b>SYNC ON G</b>	<p><b>On/Off SYNC ON G Mode:</b>            TURN ON (▼) ⇔ (▲) TURN OFF</p> <p>Selecting TURN ON turns on the SYNC ON G mode. The SYNC ON G mode allows reception of SYNC on G.</p> <ul style="list-style-type: none"> <li>• In the SYNC ON G mode, the picture may be distorted with certain input signals. In such a case, remove the signal connector so that no signal is received and turn SYNC ON G off, and then reconnect the signal.</li> </ul>

## SCREEN Menu

With the SCREEN menu, the two items shown in the Table below can be performed.

Please perform each operation in accordance with the instructions in the Table.

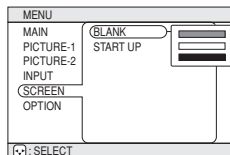

Example : SCREEN Menu (BLANK)

### SCREEN Menu

Item	Description
<p><b>BLANK</b></p>	<p><b>Selection of BLANK Screen:</b>            (▲) . (□) . (▼) ⇔ (▲) . (□) . (▼) ⇔ (▲) . (■) .</p> <p>The BLANK Screen may be voluntarily selected. The BLANK Screen is displayed when the screen has been erased (i.e., made to vanish) by manipulating the BLANK button (please refer to the “Temporarily Blanking the Screen” section of the separate booklet, Vol. 1 (Basic)).</p> <p><b>Option screens:</b> Various colored non-patterned (plain) screens displayed within the Menus.</p>
<p><b>START UP</b></p>	<p><b>Selection of START UP Screen:</b>            TURN ON (▼) ⇔ (▲) TURN OFF</p> <p>The START UP Screen may be voluntarily selected. The START UP Screen is displayed when no signal has been inputted, or when spec signals are being inputted.</p> <p><b>TURN ON:</b> Existing standard screens. Please make confirmation using the actual screen(s).</p> <p><b>TURN OFF:</b> A non-patterned (plain) blue color screen.</p> <ul style="list-style-type: none"> <li>• Note that if TURN OFF is selected the blank screen is displayed in blue when there is no signal.</li> </ul>

# MULTIFUNCTIONAL SETTINGS (continued)

## OPTION Menu

With the OPTION menu, the five items shown in the Table below can be performed.

Please perform each operation in accordance with the instructions in the Table.

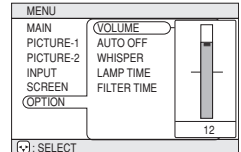

Example : OPTION Menu (VOLUME)

## OPTION Menu

Item	Description
<b>VOLUME</b>	<b>Adjust Volume:</b> High  ⇌  Low
<b>AUTO OFF</b>	<b>Adjust AUTO OFF Time:</b> Long (MAX. 99 min.)  ⇌  Short (Min. 1 min.)  ⇌  (DISABLE: 0 min.) The system automatically enters the standby mode if no signal is received within the set time. This function is inactive when DISABLE (0 min.) is selected.
<b>WHISPER</b>	<b>Select WHISPER Mode:</b> NORMAL  ⇌  WHISPER When WHISPER is selected the WHISPER mode is activated. In the WHISPER mode, acoustic noise and screen brightness are reduced.
<b>LAMP TIME</b>	<b>Refer to LAMP TIME:</b> When set, this function displays the total time the projector lamp has been used since new. <b>Reset LAMP TIME [Use this function only when the lamp has been replaced!]:</b> Depress the RESET button for at least 3 seconds while lamp time is being displayed. The reset menu will then appear. After you replace the lamp with a new lamp, select RESET on the menu with the  button. <ul style="list-style-type: none"> <li>Do not reset the lamp time unless you have replaced the lamp. And, always reset the lamp time when replacing the lamp. The message functions will not operate properly if the lamp time is not reset correctly.</li> <li>Before replacing the lamp, carefully read the descriptions headed "THE LAMP".</li> </ul>
<b>FILTER TIME</b>	<b>Refer to FILTER TIME:</b> This function displays the total time the air-filter has been used since new. <b>Reset FILTER TIME [Use this function only when the filter is cleaned or replaced!]:</b> Depress the RESET button for at least 3 seconds while lamp time is being displayed. The reset menu will then appear. After you replace the filter, select RESET on the menu with the  button. RESET  ⇌  CANCEL <ul style="list-style-type: none"> <li>Do not reset the filter time unless you have cleaned or replaced the filter. And, always reset the filter time when cleaning or replacing the filter. The message functions will not operate properly if the filter time is not reset correctly.</li> <li>Before cleaning or replacing the filter, carefully read the descriptions headed "THE AIR FILTER".</li> </ul>

# WHAT TO DO WHEN YOU THINK A MACHINE DEFECT HAS OCCURRED

## Related Messages

When the unit's power is ON, messages such as those shown below may be displayed. When any such message is displayed on the screen, please respond as described below.

Message	Description
<b>CHANGE THE LAMP AFTER REPLACING LAMP, RESET THE LAMP TIMER.</b> (Note 1)	Lamp usage time is approaching 2,000 hours. (Note 2) Preparation of a new lamp, and an early lamp change, is recommended. After you have changed the lamp, please be sure to reset the lamp timer.
<b>CHANGE THE LAMP AFTER REPLACING LAMP, RESET THE LAMP TIMER. THE POWER WILL TURN OFF AFTER ** hr.</b> (Note 1)	Lamp usage time is approaching 2,000 hours. A lamp change within ** hours is recommended. (Note 2) When lamp usage reaches 2,000 hours, the power will automatically be turned OFF. Please change the lamp by referring to "THE LAMP" in Vol.1 (Basic). After you have changed the lamp, please be sure to reset the lamp timer.
<b>CHANGE THE LAMP AFTER REPLACING LAMP, RESET THE LAMP TIMER. THE POWER WILL TURN OFF AFTER 0 hr.</b>	As lamp use has reached 2,000 hours, the power will soon be automatically turned OFF. (Note 2) Please immediately turn the power OFF, and follow the instructions in the "THE LAMP" section of the separate booklet, Vol.1 (Basic). After you have changed the lamp, please be sure to reset the lamp timer.
<b>CLEAN THE AIR FILTER AFTER CLEANING AIR FILTER, RESET THE FILTER TIMER.</b>	A note of precaution when cleaning the air filter. After cleaning the filter, operate FILTER TIME of the OPTION Menu, and perform reset of the filter timer.
<b>NO INPUT IS DETECTED ON ***</b>	There is no input signal. Please confirm the signal input connection, and the status of the signal source.
<b>SYNC IS OUT OF RANGE</b> ON *** <b>fH</b> *****kHz <b>fV</b> *****Hz	The horizontal or vertical wavelength of the inputted signal is outside of the response parameters of this unit. Please confirm the specs for this unit or the signal source specs.
<b>CHECK THE AIR FLOW</b>	The internal portion temperature is rising. Please turn the power OFF, and allow the unit to cool down for approximately 20 minutes. After having confirmed the following items, then please reset the power to ON. <ul style="list-style-type: none"> <li>• Is there blockage of the air passage aperture?</li> <li>• Is the air filter dirty?</li> <li>• Does the peripheral temperature exceed 35°C?</li> </ul>

### NOTES

Note 1: Although this message will be automatically disappeared after around 3 minutes, it will be reappeared every time the power is turned ON.

Note 2: Lamps have a finite product life. Lamps are characterized by the fact that, after long hours of usage, a lamp will no longer light up, or the lamp will break or burst, etc. This unit is equipped with an automatic shut-down function, such that the power will automatically be turned OFF when lamp usage time has reached 2,000 hours. Please be aware, however, that among lamp types, there are major differences in product lifetimes; a lamp may thus fail to light even prior to the functioning of the automatic shut-down function of this unit.

# WHAT TO DO WHEN YOU THINK A MACHINE DEFECT HAS OCCURRED (continued)

## Regarding the Indicator Lamps

Lighting and flashing of the POWER indicator, the LAMP indicator, and the TEMP indicator have the meanings as described in the Table below. Please respond in accordance with the instructions within the Table.

POWER indicator	LAMP indicator	TEMP indicator	Description
The orange lamp is lighted	Turned OFF (Not lighted)	Turned OFF (Not lighted)	The STANDBY mode is set
Flashing of the green lamp	Turned OFF	Turned OFF	The unit is warming up. Please wait.
The green lamp is lighted	Turned OFF	Turned OFF	The unit is in an ON state. Ordinary operations may be performed.
Flashing of the orange lamp	Turned OFF	Turned OFF	The unit is cooling down. Please wait.
Blinking of the red lamp	-	-	The unit is cooling down. Please wait. A certain error has been detected. Wait until the POWER indicator lamp has finished flashing, and then perform the proper response measure using the item descriptions below as reference.
The red lamp is lighted, or blinks	The red lamp is lighted	Turned OFF	The lamp does not light. There is a possibility that the interior portion has become heated. Turn the power OFF and wait approximately 20 minutes. After the main unit has cooled down, please confirm whether or not there is blockage of the air passage aperture, whether or not the filter is dirty, and/or whether or not the peripheral temperature exceeds 35°C, etc. After performing any needed maintenance, turn the power ON again; if the same display is displayed, then please change the lamp.
The red lamp is lighted, or blinks	Blinking of the red lamp	Turned OFF	Either there is no lamp and/or lamp cover, or either of these has not been properly fixed (attached). Turn the power OFF and wait approximately 45 minutes. After the main unit has sufficiently cooled down, please make confirmation of the attachment state of the lamp and lamp cover. After performing any needed maintenance, turn the power ON again; if the same display is displayed, then please contact a sales store or a service company.
The red lamp is lighted, or blinks	Turned OFF	Blinking of the red lamp	The cooling fan is not operating. Turn the power OFF and wait approximately 20 minutes. After the main unit has cooled down, please make confirmation that no foreign matter has become caught in the fan, etc. After performing any needed maintenance, turn the power ON again; if the same display is displayed, then please contact a sales store or a service company.
The red lamp is lighted, or blinks	Turned OFF	The red lamp is lighted	There is a possibility that the interior portion has become heated. Turn the power OFF and wait approximately 20 minutes. After the main unit has cooled down, please confirm whether or not there is blockage of the air passage aperture, whether or not the filter is dirty, and/or whether or not the peripheral temperature exceeds 35°C, etc. After performing any needed maintenance, turn the power ON again; if the same display is displayed, then please contact a sales store or a service company.
The green lamp is lighted	Alternative blinking with the red lamp		There is a possibility that the interior portion has become overcooled. Please use the unit within the usage temperature parameters (0°C to 35°C). After performing any needed maintenance, turn the power ON again; if the same display is displayed, then please contact a sales store or a service company.
The green lamp is lighted	Simultaneous blinking with the red lamp		This is a notification that it is time to clean the filter. After cleaning the filter, operate the FILTER TIME portion of the OPTION Menu, and perform reset of the FILTER TIME.

### NOTE

When the interior portion has become overheated, for safety purposes, the power source is automatically turned OFF, and the indicator lamps may also be turned OFF. Press the "O" (power OFF) side of the main power switch, and wait for approximately 20 minutes. Please then use the unit only after having first confirmed that the unit has sufficiently cooled down.

## Phenomena That May Easily Be Mistaken for Machine Defects

Before requesting repair, check in accordance with the following chart.  
 If the situation cannot be corrected, then contact your dealer.

Phenomenon	Cases not involving a machine defect	Items to be confirmed	Reference Page(s)
Power does not come ON	The main power source is not ON.	Turn on the main power.	Vol.1-3, 14
	The electrical power cord is not plugged in.	Correctly connect the power cord.	
	The main power source has been interrupted during operation, such as by a power outage (blackout), etc.	Be sure to press the "O" (power OFF) side of the main power switch, and leave this OFF for approximately 20 minutes. After the unit has sufficiently cooled down, turn ON the power source.	Vol.1-14
No sound or pictures are outputted	The input changeover settings are mismatched.	Select the input signal, and correct the settings.	Vol.1-15
	No signal is being inputted.	Correctly connect the connection cord.	Vol.1-10, 11
Pictures are displayed, but no sounds are heard	The electrical wiring to this unit is not correctly connected.	Correctly connect the connection cord.	Vol.1-10, 11
	The volume setting has been set at (or adjusted to) an extremely low level.	Adjust the VOLUME setting to a higher level.	Vol.1-17
	The MUTE mode is the current setting.	Press the MUTE button to release (change) the MUTE mode setting.	Vol.1-17
Sounds are heard, but no pictures are displayed	The electrical wiring to this unit is not correctly connected.	Correctly connect the connection cord.	Vol.1-10, 11
	The brightness setting has been set at (or adjusted to) an extremely low level.	Adjust the BRIGHT setting to a brighter level.	Vol.2-2
	The Slide lens door has not been removed.	Remove the Slide lens door.	Vol.1-14
Colors have a faded-out appearance Color tone is poor	Color depth setting or color tone setting	Perform picture adjustments by changing the COLOR BAL R, the COLOR BAL B, and/or the TINT settings, etc.	Vol.2-3
Pictures appear dark	The brightness setting and/or contrast setting has not been properly adjusted.	Perform picture adjustments by changing the BRIGHT and/or CONTRAST settings, etc.	Vol.2-2
	The WHISPER mode is the current setting.	Change (by releasing) from the WHISPER mode.	Vol.2-6
	Lamp is approaching the end of its product lifetime.	Exchange the old lamp with a new lamp.	Vol.1-24, 25
Pictures appear blurry	Either the FOCUS setting or the H PHASE is not properly adjusted.	Adjust the FOCUS and H PHASE settings.	Vol.1-15 Vol.2-3

**NOTE**  
 Although bright spots or dark spots may appear on the screen, this is a unique characteristic of liquid crystal displays, and such do not constitute or imply a machine defect.

# SPECIFICATIONS

**NOTE** • This specifications are subject to change without notice.

Item		Specification																		
Product name		Liquid crystal projector																		
Liquid crystal panel	Panel size	1.8 cm (0.7 type)																		
	Drive system	TFT active matrix																		
	Pixels	CP-S225 : 480,000 pixels (800 horizontal x600 vertical) CP-X275 : 786,432 pixels (1024 horizontal x 768 vertical)																		
Lens		Zoom lens F=2.0 ~ 2.3 f=18 ~ 21 mm																		
Lamp		150 W UHB																		
Speaker		1.0W																		
Power supply		AC100 ~ 120V, 2.7A / AC220 ~ 240V, 1.3A																		
Power consumption		240W																		
Temperature range		0 ~ 35°C (Operating)																		
Size		289 (W) x 84 (H) x 215 (D) mm																		
Weight (mass)		2.4 kg																		
Ports		<table border="0"> <tr> <td><b>RGB Port</b></td> <td></td> <td><b>AUDIO Ports</b></td> </tr> <tr> <td>RGB IN .....</td> <td>1</td> <td>AUDIO IN(R, L) .....</td> </tr> <tr> <td><b>VIDEO Ports</b></td> <td></td> <td>AUDIO IN .....</td> </tr> <tr> <td>VIDEO IN .....</td> <td>1</td> <td><b>CONTROL Port</b></td> </tr> <tr> <td>S-VIDEO IN .....</td> <td>1</td> <td>CONTROL .....</td> </tr> <tr> <td>COMPONENT VIDEO (Y, Cb/Pb,Cr/Pr) .....</td> <td>1</td> <td></td> </tr> </table>	<b>RGB Port</b>		<b>AUDIO Ports</b>	RGB IN .....	1	AUDIO IN(R, L) .....	<b>VIDEO Ports</b>		AUDIO IN .....	VIDEO IN .....	1	<b>CONTROL Port</b>	S-VIDEO IN .....	1	CONTROL .....	COMPONENT VIDEO (Y, Cb/Pb,Cr/Pr) .....	1	
<b>RGB Port</b>		<b>AUDIO Ports</b>																		
RGB IN .....	1	AUDIO IN(R, L) .....																		
<b>VIDEO Ports</b>		AUDIO IN .....																		
VIDEO IN .....	1	<b>CONTROL Port</b>																		
S-VIDEO IN .....	1	CONTROL .....																		
COMPONENT VIDEO (Y, Cb/Pb,Cr/Pr) .....	1																			
Optional Parts		Lamp: CP-S225=DT00401, CP-X275=DT00461 Air Filter: MU01461 * For others, consult your dealer.																		

## Dimension Diagram

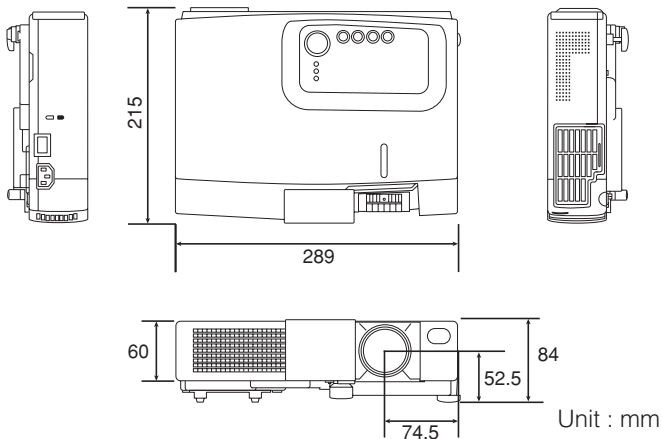



## WARRANTY AND AFTER-SERVICE

If a problem occurs with the equipment, first refer to the  7 “WHAT TO DO WHEN YOU THINK A MACHINE DEFECT HAS OCCURRED” section and run through the suggested checks. If this does not resolve the problem contact your dealer or service company. They will tell you what warranty condition is applied.

# TECHNICAL

## SIGNAL CONNECTOR PIN ASSIGNMENT

RGB IN [1]/[2]  
RGB OUT

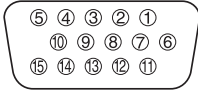

D-sub 15-pin Shrink

S-VIDEO

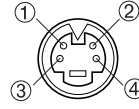

Mini Din 4-pin

Pin No	Signal	Pin No	Signal
1	Video input Red	9	-
2	Video input Green	10	Ground
3	Video input Blue	11	-
4	-	12	RGB IN [1]: SDA (DDC)
5	Ground		RGB IN [2]: -
6	Ground Red		RGB OUT : -
7	Ground Green	13	H. sync./ Composite sync.
8	Ground Blue	14	Vertical sync
		15	RGB IN [1]: SCL (DDC)
			RGB IN [2]: -
			RGB OUT : -

Mini Din 4-pin	
Pin No	Signal
1	Color: 0.286Vp-p (NTSC, burst signal), 75Ω terminator 0.3Vp-p (PAL/SECAM, burst signal), 75Ω terminator
2	Brightness: 1.0Vp-p, 75Ω terminator
3	Ground
4	Ground

signal	Terminal	Specification	
RGB signal input	RGB IN	Video: Analog 0.7Vp-p, 75Ω terminator (positive) H/V. sync.: TTL level (positive/negative) Composite sync.: TTL level D-sub 15-pin shrink jack	
AUDIO input (from the computer)	AUDIO IN	200mVrms, 50 kΩ (max. 3.0Vp-p) Stereo mini jack	
Video signal input	VIDEO IN	1.0Vp-p, 75Ω terminator, RCA jack	
	COMPONENT VIDEO	S-VIDEO IN	Brightness signal: 1.0Vp-p, 75Ω terminator Color signal: 0.286Vp-p (NTSC, burst signal), 75Ω terminator 0.300Vp-p (PAL/SECAM, burst signal), 75Ω terminator Mini DIN 4-pin jack
		Y	1.0 Vp-p, 75 Ω Terminator (Positive)
		Cb/Pb	0.7 Vp-p, 75 Ω Terminator (Positive)
	Cr/Pr	0.7 Vp-p, 75 Ω Terminator (Positive)	
Audio input (from video equipment)	AUDIO IN (R, L)	200mVrms, 50 kΩ (max. 3.0Vp-p) RCA jack	

## EXAMPLE OF COMPUTER SIGNAL

Resolution H × V	fH (kHz)	fV (Hz)	Rating	Signal mode	Display mode	
					CP-S225WA	CP-X275WA
720 × 400	37.9	85.0	VESA	TEXT	Zoom in	Zoom in
640 × 480	31.5	59.9	VESA	VGA (60Hz)	Zoom in	Zoom in
640 × 480	35.0	66.7		Mac13"mode	Zoom in	Zoom in
640 × 480	37.9	72.8	VESA	VGA (72Hz)	Zoom in	Zoom in
640 × 480	37.5	75.0	VESA	VGA (75Hz)	Zoom in	Zoom in
640 × 480	43.3	85.0	VESA	VGA (85Hz)	Zoom in	Zoom in
800 × 600	35.2	56.3	VESA	SVGA (56Hz)		Zoom in
800 × 600	37.9	60.3	VESA	SVGA (60Hz)		Zoom in
800 × 600	48.1	72.2	VESA	SVGA (72Hz)		Zoom in
800 × 600	46.9	75.0	VESA	SVGA (75Hz)		Zoom in
800 × 600	53.7	85.1	VESA	SVGA (85Hz)		Zoom in
832 × 624	49.7	74.5		Mac16"mode	Zoom out	Zoom in
1024 × 768	48.4	60.0	VESA	XGA (60Hz)	Zoom out	
1024 × 768	56.5	70.1	VESA	XGA (70Hz)	Zoom out	
1024 × 768	60.0	75.0	VESA	XGA (75Hz)	Zoom out	
1024 × 768	68.7	85.0	VESA	XGA (85Hz)	Zoom out	
1152 × 864	67.5	75.0	VESA	SXGA (75Hz)	Zoom out	Zoom out
1280 × 960	60.0	60.0	VESA	SXGA (60Hz)	Zoom out	Zoom out
1280 × 1024	64.0	60.0	VESA	SXGA (60Hz)	Zoom out	Zoom out
1280 × 1024	80.0	75.0	VESA	SXGA (75Hz)	Zoom out	Zoom out
1280 × 1024	91.2	85.0	VESA	SXGA (85Hz)	Zoom out	Zoom out
1600 × 1200	75.0	60.0	VESA	UXGA (60Hz)	Zoom out	Zoom out

- NOTE** • Some computers may have multiple display screen modes. Use of some of these modes will not be possible with this projector.
- Be sure to check jack type, signal level, timing and resolution before connecting this projector to a computer.
  - Depending on the input signal, full-size display may not be possible in some cases. Refer to the number of display pixels above.
  - This projector will display up to UXGA (1600X1200) resolution signals but the image will be rescaled to the native resolution of the projector. Best display performance is achieved when the signal input resolution is the same as the native resolution of the projector.
  - The image may not be displayed correctly when the input sync. signal is "Composite Sync." or "Sync. on G".

# INITIAL SET SIGNALS

The following signals are used for the initial settings.

The signal timing of some computer models may be different. In such case, refer to adjust the V.POSIT and H.POSIT of the menu.

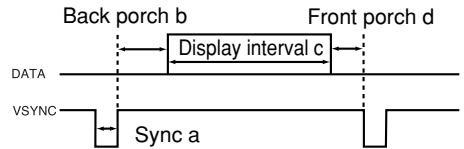
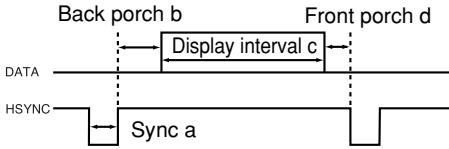

Computer / Signal	Horizontal signal timing (μs)			
	a	b	c	d
TEXT	2.0	3.0	20.3	1.0
VGA (60Hz)	3.8	1.9	25.4	0.6
Mac 13"mode	2.1	3.2	21.2	2.1
VGA (72Hz)	1.3	3.8	20.3	1.0
VGA (75Hz)	2.0	3.8	20.3	0.5
VGA (85Hz)	1.6	2.2	17.8	1.6
SVGA (56Hz)	2.0	3.6	22.2	0.7
SVGA (60Hz)	3.2	2.2	20.0	1.0
SVGA (72Hz)	2.4	1.3	16.0	1.1
SVGA (75Hz)	1.6	3.2	16.2	0.3
SVGA (85Hz)	1.1	2.7	14.2	0.6
Mac 16"mode	1.1	3.9	14.5	0.6
XGA (60Hz)	2.1	2.5	15.8	0.4
XGA (70Hz)	1.8	1.9	13.7	0.3
XGA (75Hz)	1.2	2.2	13.0	0.2
XGA (85Hz)	1.0	2.2	10.8	0.5
1152x864 (75Hz)	1.2	2.4	10.7	0.6
1280x960 (60Hz)	1.0	2.9	11.9	0.9
1280x1024 (60Hz)	1.0	2.3	11.9	0.4
1280x1024 (75Hz)	1.1	1.8	9.5	0.2
1280x1024 (85Hz)	1.0	1.4	8.1	0.4
1600x1200 (60Hz)	1.2	1.9	9.9	0.4

Computer / Signal	Vertical signal timing (lines)			
	a	b	c	d
TEXT	3	42	400	1
VGA (60Hz)	2	33	480	10
Mac 13"mode	3	39	480	3
VGA (72Hz)	3	28	480	9
VGA (75Hz)	3	16	480	1
VGA (85Hz)	3	25	480	1
SVGA (56Hz)	2	22	600	1
SVGA (60Hz)	4	23	600	1
SVGA (72Hz)	6	23	600	37
SVGA (75Hz)	3	21	600	1
SVGA (85Hz)	3	27	600	1
Mac 16"mode	3	39	624	1
XGA (60Hz)	6	29	768	3
XGA (70Hz)	6	29	768	3
XGA (75Hz)	3	28	768	1
XGA (85Hz)	3	36	768	1
1152x864 (75Hz)	3	32	864	1
1280x960 (60Hz)	3	36	960	1
1280x1024 (60Hz)	3	38	1024	1
1280x1024 (75Hz)	3	37	1024	2
1280x1024 (85Hz)	3	44	1024	1
1600x1200 (60Hz)	3	46	1200	1

# RS-232C COMMUNICATION

- (1) Turn off the projector and computer power supplies and connect with the RS-232C cable.
- (2) Turn on the computer power supply and after the computer has started up, turn on the projector power supply.

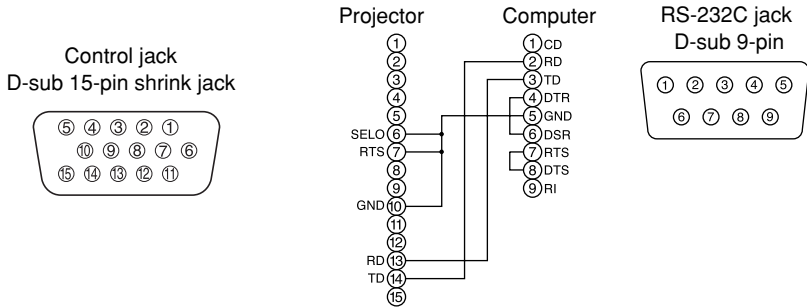

## Communications setting

19200bps, 8N1

### 1 Protocol

Consist of header (7 bytes) + command data (6 bytes).

### 2 Header

BE + EF + 03 + 06 + 00 + CRC\_low + CRC\_high

CRC\_low : Lower byte of CRC flag for command data.

CRC\_high : Upper byte of CRC flag for command data.

### 3 Command data

Command data chart

byte_0	byte_1	byte_2	byte_3	byte_4	byte_5
Action		Type		Setting code	
low	high	low	high	low	high

Action (byte\_0 - 1)

Action	Classification	Content
1	SET	Change setting to desired value.
2	GET	Read projector internal setup value.
4	INCREMENT	Increment setup value by 1.
5	DECREMENT	Decrement setup value by 1.
6	EXECUTE	Run a command.

### Requesting projector status (Get command)

- (1) Send the request code Header + Command data ('02H'+ '00H'+ type (2 bytes) + '00H'+ '00H') from the computer to the projector.
- (2) The projector returns the response code '1DH'+ data (2 bytes) to the computer.

### Changing the projector settings (Set command)

- (1) Send the setting code Header + Command data ('01H'+ '00H'+ type (2 bytes) + setting code (2 bytes)) from the computer to the projector.
- (2) The projector changes the setting based on the above setting code.
- (3) The projector returns the response code '06H' to the computer.

### Using the projector default settings (Reset Command)

- (1) The computer sends the default setting code Header + Command data ('06H'+ '00H'+ type (2 bytes) + '00H'+ '00H') to the projector.
- (2) The projector changes the specified setting to the default value.
- (3) The projector returns the response code '06H' to the computer.

### Increasing the projector setting value (Increment command)

- (1) The computer sends the increment code Header + Command data ('04H'+ '00H'+ type (2 bytes) + '00H'+ '00H') to the projector.
- (2) The projector increases the setting value on the above setting code.
- (3) The projector returns the response code '06H' to the computer.

### Decreasing the projector setting value (Decrement command)

- (1) The computer sends the decrement code Header + Command data ('05H'+ '00H'+ type (2 bytes) + '00H'+ '00H') to the projector.
- (2) The projector decreases the setting value on the above setting code.
- (3) The projector returns the response code '06H' to the computer.

### When a command sent by the projector cannot be understood by the computer

When the command sent by the projector cannot be understood, the error command '15H' is returned by the computer. Some times, the projector ignores RS-232C commands during other works. If the error command '15H' is returned, please send the same command again.

### When data sent by the projector cannot be practice

When the command sent by the projector cannot be practiced, the the error code '1cH'+ 'xxxxH' is returned.

When the data length is greater than indicated by the data length code, the projector will ignore the excess data code.

Conversely, when the data length is shorter than indicated by the data length code, an error code will be returned to the projector.

- NOTE**
- Operation cannot be guaranteed when the projector receives an undefined command or data.
  - Provide an interval of at least 40ms between the response code and any other code.
  - The projector outputs test data when the power supply is switched ON, and when the lamp is lit. Ignore this data.
  - Commands are not accepted during warm-up.

# RS-232C COMMUNICATION (continued)

## Command data chart

Names	Operation type		Header				Command data								
						CRC	Action	Type	Setting code						
Blank Color	Set	Blue	BE	EF	03	06	00	CB	D3	01	00	00	30	03	00
		White	BE	EF	03	06	00	6B	D0	01	00	00	30	05	00
		Black	BE	EF	03	06	00	9B	D0	01	00	00	30	06	00
		Get	BE	EF	03	06	00	08	D3	02	00	00	30	00	00
Mirror	Set	Normal	BE	EF	03	06	00	C7	D2	01	00	01	30	00	00
		H Inverse	BE	EF	03	06	00	57	D3	01	00	01	30	01	00
		V Inverse	BE	EF	03	06	00	A7	D3	01	00	01	30	02	00
		H&V Inverse	BE	EF	03	06	00	37	D2	01	00	01	30	03	00
		Get	BE	EF	03	06	00	F4	D2	02	00	01	30	00	00
Freeze	Set	Normal	BE	EF	03	06	00	83	D2	01	00	02	30	00	00
		Freeze	BE	EF	03	06	00	13	D3	01	00	02	30	01	00
		Get	BE	EF	03	06	00	B0	D2	02	00	02	30	00	00
Startup	Set	TURN ON	BE	EF	03	06	00	0B	D2	01	00	04	30	00	00
		TURN OFF	BE	EF	03	06	00	9B	D3	01	00	04	30	01	00
		Get	BE	EF	03	06	00	38	D2	02	00	04	30	00	00
Language	Set	English	BE	EF	03	06	00	F7	D3	01	00	05	30	00	00
		Français	BE	EF	03	06	00	67	D2	01	00	05	30	01	00
		Deutsch	BE	EF	03	06	00	97	D2	01	00	05	30	02	00
		Español	BE	EF	03	06	00	07	D3	01	00	05	30	03	00
		Italiano	BE	EF	03	06	00	37	D1	01	00	05	30	04	00
		Norsk	BE	EF	03	06	00	A7	D0	01	00	05	30	05	00
		Nederlands	BE	EF	03	06	00	57	D0	01	00	05	30	06	00
		Português	BE	EF	03	06	00	C7	D1	01	00	05	30	07	00
		日本語	BE	EF	03	06	00	37	D4	01	00	05	30	08	00
		中文	BE	EF	03	06	00	A7	D5	01	00	05	30	09	00
	한글	BE	EF	03	06	00	57	D5	01	00	05	30	0A	00	
	Get	BE	EF	03	06	00	C4	D3	02	00	05	30	00	00	
Magnify		Get	BE	EF	03	06	00	7C	D2	02	00	07	30	00	00
		Increment	BE	EF	03	06	00	1A	D2	04	00	07	30	00	00
		Decrement	BE	EF	03	06	00	CB	D3	05	00	07	30	00	00
Auto off		Get	BE	EF	03	06	00	08	86	02	00	10	31	00	00
		Increment	BE	EF	03	06	00	6E	86	04	00	10	31	00	00
		Decrement	BE	EF	03	06	00	BF	87	05	00	10	31	00	00
Brightness Reset		Execute	BE	EF	03	06	00	58	D3	06	00	00	70	00	00
Contrast Reset		Execute	BE	EF	03	06	00	A4	D2	06	00	01	70	00	00
V.Position Reset		Execute	BE	EF	03	06	00	E0	D2	06	00	02	70	00	00

Names	Operation type		Header			Command data			
						CRC	Action	Type	Setting code
H.Position Reset	Execute		BE EF	03 06 00	IC D3	06 00	03 70	00 00	
H.Size Reset	Execute		BE EF	03 06 00	68 D2	06 00	04 70	00 00	
Color Balance R Reset	Execute		BE EF	03 06 00	94 D3	06 00	05 70	00 00	
Color Balance B Reset	Execute		BE EF	03 06 00	D0 D3	06 00	06 70	00 00	
Sharpness Reset	Execute		BE EF	03 06 00	C4 D0	06 00	09 70	00 00	
Color Reset	Execute		BE EF	03 06 00	80 D0	06 00	0A 70	00 00	
Tint Reset	Execute		BE EF	03 06 00	7C D1	06 00	0B 70	00 00	
Keystone_V Reset	Execute		BE EF	03 06 00	08 D0	06 00	0C 70	00 00	
Auto Adjust	Execute		BE EF	03 06 00	91 D0	06 00	0A 20	00 00	
Lamp Time Reset	Execute		BE EF	03 06 00	58 DC	06 00	30 70	00 00	
Filter Time Reset	Execute		BE EF	03 06 00	98 C6	06 00	40 70	00 00	
Blank on/off	Set	off	BE EF	03 06 00	FB D8	01 00	20 30	00 00	
		on	BE EF	03 06 00	6B D9	01 00	20 30	01 00	
	Get	BE EF	03 06 00	C8 D8	02 00	20 30	00 00		
Error Status	Get		BE EF	03 06 00	D9 D8	02 00	20 60	00 00	
		(Example of Return)							
			00 00	01 00	02 00	03 00			
			(Normal)	(Cover-error)	(Fan-error)	(Lamp-error)			
			04 00	05 00	06 00	07 00	08 00		
			(Temp-error)	(Air flow-error)	(Lamp-Time-over)	(Cool-error)	(Filter-Error)		
Power	Set	OFF	BE EF	03 06 00	2A D3	01 00	00 60	00 00	
		ON	BE EF	03 06 00	BA D2	01 00	00 60	01 00	
	Get	BE EF	03 06 00	19 D3	02 00	00 60	00 00		
Input Source	Set	RGB	BE EF	03 06 00	FE D2	01 00	00 20	00 00	
		Video	BE EF	03 06 00	6E D3	01 00	00 20	01 00	
		SVideo	BE EF	03 06 00	9E D3	01 00	00 20	02 00	
		Component	BE EF	03 06 00	AE D1	01 00	00 20	05 00	
	Get	BE EF	03 06 00	CD D2	02 00	00 20	00 00		
Volume	Get	BE EF	03 06 00	31 D3	02 00	01 20	00 00		
	Increment	BE EF	03 06 00	57 D3	04 00	01 20	00 00		
	Decrement	BE EF	03 06 00	86 D2	05 00	01 20	00 00		
Mute	Set	Normal	BE EF	03 06 00	46 D3	01 00	02 20	00 00	
		Mute	BE EF	03 06 00	D6 D2	01 00	02 20	01 00	
	Get	BE EF	03 06 00	75 D3	02 00	02 20	00 00		
Brightness	Get	BE EF	03 06 00	89 D2	02 00	03 20	00 00		
	Increment	BE EF	03 06 00	EF D2	04 00	03 20	00 00		
	Decrement	BE EF	03 06 00	3E D3	05 00	03 20	00 00		



## Command data chart (continued)

Names	Operation type	Header			Command data										
					CRC	Action	Type	Setting code							
Contrast	Get	BE	EF	03	06	00	FD	D3	02	00	04	20	00	00	
	Increment	BE	EF	03	06	00	9B	D3	04	00	04	20	00	00	
	Decrement	BE	EF	03	06	00	4A	D2	05	00	04	20	00	00	
Color Balance R	Get	BE	EF	03	06	00	01	D2	02	00	05	20	00	00	
	Increment	BE	EF	03	06	00	67	D2	04	00	05	20	00	00	
	Decrement	BE	EF	03	06	00	B6	D3	05	00	05	20	00	00	
Color Balance B	Get	BE	EF	03	06	00	45	D2	02	00	06	20	00	00	
	Increment	BE	EF	03	06	00	23	D2	04	00	06	20	00	00	
	Decrement	BE	EF	03	06	00	F2	D3	05	00	06	20	00	00	
Keystone_V	Get	BE	EF	03	06	00	B9	D3	02	00	07	20	00	00	
	Increment	BE	EF	03	06	00	DF	D3	04	00	07	20	00	00	
	Decrement	BE	EF	03	06	00	0E	D2	05	00	07	20	00	00	
Aspect	Set	4:3	BE	EF	03	06	00	9E	D0	01	00	08	20	00	00
		16:9	BE	EF	03	06	00	0E	D1	01	00	08	20	01	00
		Small	BE	EF	03	06	00	FE	D1	01	00	08	20	02	00
	Get	BE	EF	03	06	00	AD	D0	02	00	08	20	00	00	
Picture Position at 16 : 9 or Small	Set	Default	BE	EF	03	06	00	62	D1	01	00	09	20	00	00
		Bottom	BE	EF	03	06	00	F2	D0	01	00	09	20	01	00
		Top	BE	EF	03	06	00	02	D0	01	00	09	20	02	00
	Get	BE	EF	03	06	00	51	D1	02	00	09	20	00	00	
V.Position	Get	BE	EF	03	06	00	0D	83	02	00	00	21	00	00	
	Increment	BE	EF	03	06	00	6B	83	04	00	00	21	00	00	
	Decrement	BE	EF	03	06	00	BA	82	05	00	00	21	00	00	
H.Position	Get	BE	EF	03	06	00	F1	82	02	00	01	21	00	00	
	Increment	BE	EF	03	06	00	97	82	04	00	01	21	00	00	
	Decrement	BE	EF	03	06	00	46	83	05	00	01	21	00	00	
H.Size	Get	BE	EF	03	06	00	B5	82	02	00	02	21	00	00	
	Increment	BE	EF	03	06	00	D3	82	04	00	02	21	00	00	
	Decrement	BE	EF	03	06	00	02	83	05	00	02	21	00	00	
H.Phase	Get	BE	EF	03	06	00	49	83	02	00	03	21	00	00	
	Increment	BE	EF	03	06	00	2F	83	04	00	03	21	00	00	
	Decrement	BE	EF	03	06	00	FE	82	05	00	03	21	00	00	
Sharpness	Get	BE	EF	03	06	00	F1	72	02	00	01	22	00	00	
	Increment	BE	EF	03	06	00	97	72	04	00	01	22	00	00	
	Decrement	BE	EF	03	06	00	46	73	05	00	01	22	00	00	
Color	Get	BE	EF	03	06	00	B5	72	02	00	02	22	00	00	
	Increment	BE	EF	03	06	00	D3	72	04	00	02	22	00	00	
	Decrement	BE	EF	03	06	00	02	73	05	00	02	22	00	00	

Names	Operation type	Header				Command data									
					CRC	Action	Type	Setting code							
Tint	Get	BE	EF	03	06	00	49	73	02	00	03	22	00	00	
	Increment	BE	EF	03	06	00	2F	73	04	00	03	22	00	00	
	Decrement	BE	EF	03	06	00	FE	72	05	00	03	22	00	00	
Video Format	Set	Auto	BE	EF	03	06	00	9E	75	01	00	00	22	0A	00
		NTSC	BE	EF	03	06	00	FE	71	01	00	00	22	04	00
		PAL	BE	EF	03	06	00	6E	70	01	00	00	22	05	00
		SECAM	BE	EF	03	06	00	6E	75	01	00	00	22	09	00
		NTSC 4.43	BE	EF	03	06	00	5E	72	01	00	00	22	02	00
		M-PAL	BE	EF	03	06	00	FE	74	01	00	00	22	08	00
	N-PAL	BE	EF	03	06	00	0E	71	01	00	00	22	07	00	
Get	BE	EF	03	06	00	0D	73	02	00	00	22	00	00		
HDTV	Set	1080i	BE	EF	03	06	00	F2	73	01	00	05	22	00	00
		1035i	BE	EF	03	06	00	62	72	01	00	05	22	01	00
	Get	BE	EF	03	06	00	C1	73	02	00	05	22	00	00	
Sync on G	Set	off	BE	EF	03	06	00	CB	D0	01	00	08	30	01	00
		on	BE	EF	03	06	00	5B	D1	01	00	08	30	00	00
	Get	BE	EF	03	06	00	68	D1	02	00	08	30	00	00	
WHISPER	Set	NORMAL	BE	EF	03	06	00	3B	23	01	00	00	33	00	00
		WHISPER	BE	EF	03	06	00	AB	22	01	00	00	33	01	00
	Get	BE	EF	03	06	00	08	23	02	00	00	33	00	00	
GAMMA	Set	NORMAL	BE	EF	03	06	00	C7	F0	01	00	A1	30	00	00
		CINEMA	BE	EF	03	06	00	57	F1	01	00	A1	30	01	00
		DYNAMIC	BE	EF	03	06	00	A7	F1	01	00	A1	30	02	00
Get	BE	EF	03	06	00	F4	F0	02	00	A1	30	00	00		
Lamp Time	Get	BE	EF	03	06	00	C2	FF	02	00	90	10	00	00	
Filter Time	Get	BE	EF	03	06	00	C2	F0	02	00	A0	10	00	00	

# HITACHI

## **Hitachi America, Ltd.**

Computer Division 2000 Sierra Point Parkway,  
MS760 Brisbane, CA 94005-1835  
Tel: +1-800-225-1741 Fax: +1-650-244-7776  
www.hitachi.com/lcd.

## **Hitachi Canada, Ltd.**

6740 Campobello Road, Mississauga, Ontario  
L5N2L8, Canada  
Tel: +1-905-821-4545 Fax: +1-905-821-1101

## **Hitachi Home Electronics (Europe), Ltd.**

Dukes Meadow, Millboard Road, Bourne End,  
Buckinghamshire SL8 5XF UK  
Tel: +44-162-864-3000 Fax: +44-162-864-3400

## **Hitachi Home Electronics Europe Ltd**

426 Bergensesteenweg, 1500 Halle, Belgium  
Tel: +32-2-363-9901 Fax: +34-2-363-9900

## **Hitachi Home Electronics Europe Ltd**

Gewerbepark, Hintermattlistr, Postfach, 5506  
Magenwil, Switzerland  
Tel: +41-62-889-8011 Fax: +41-62-896-4771

## **Hitachi Europe GmbH**

Business Systems Division  
Via T. Gulli. 39, 20147 Milano, Italy  
Tel: +39-2-487861 Fax: +39-2-48786322

## **Hitachi Sales Europe GmbH**

Business Systems Division  
Am Seestern 18, 40547 Dusseldorf, Germany  
Tel: +49-211-529-1551 Fax: +49-211-529-1594

## **Hitachi Business Systems (Nordic)**

Brugata 14, N-0184 Oslo, Norway  
Tel: +47-2205-9060 Fax: +47-2205-9061

## **Hitachi Business Systems (Nordic)**

Domnarvsgatan 29, Lunda, Box 62, S-163 91  
Spanga, Sweden  
Tel: +46-8-621-8260 Fax: +46-8-761-6250

## **Hitachi Business Systems (Nordic)**

Kuldysen 13, DK-2630 Tåstrup, Denmark  
Tel: +45-43-99-9200 Fax: +45-43-99-9392

## **Hitachi Business Systems (Nordic)**

Tapiolan Keskustorni 11 Krs. Fin-02100 Espoo,  
Finland  
Tel: +358-9-3487-1188 Fax: +358-9-455-2152

## **Hitachi France**

Immeuble, 'Ariane', 18 Rue Grange Dame Rose,  
B.P. 134, 78148 Velizy, Cedex, France  
Tel: +33-1-34630542 Fax: +33-1-34650761

## **Hitachi Sales Iberica S A**

Gran Via Carlos 111, 101, 1-1, 08028 Barcelona,  
Spain  
Tel: +34-3-330-8652 Fax: +34-3-339-7839

## **Hitachi Home Electronics Asia, (S) Pte Ltd.**

16 Collyer Quay #20-00 Hitachi Tower Singapore  
049318, Singapore  
Tel: +65-536-2520 Fax: +65-536-2521

## **Hitachi Sales (Malaysia) Sdn. Bhd.**

Wisma Hitachi, No.2, Lorong 13/6A, 46200  
Petaling  
Jaya, Selangor Darul Ehsan, Malaysia  
Tel: +60-3-7573455 Fax: +60-3-7556090

## **Hitachi Sales (Thailand), Ltd.**

994,996 Soi Thonglor, Sukhumvit 55 Road,  
Klongton,  
Klongtoey, Bangkok 10110, Thailand  
Tel: +66-2-381-8381 Fax: +66-2-381-9520

## **Hitachi (Hong Kong), Ltd.**

8th Floor Park-in Commercial Centre, No.56,  
Dundas  
Street, Kowloon Bay, Kowloon, Hong Kong  
Tel: +852-2-7804351 Fax: +852-2-7804915

## **Hitachi Sales Corp. of Taiwan.**

2nd Floor, No.65, Nanking East Road, Section 3,  
Taipei, Taiwan  
Tel: +886-2-516-0500 Fax: +886-2-516-1501

## **Hitachi Australia Ltd.**

13-15 Lyonpark Road, North Ryde NSW 2113,  
Australia  
Tel: +61-2-9888-4100 Fax: +61-2-9888-4144

## **Hitachi, Ltd.**

15-12, Nishi Simbashi 2-chome, Minato-ku, Tokyo,  
105 Japan  
Tel: +81-3-3502-2111 Fax: +81-3-3506-1440



\*QR55481\*

Printed in Japan